

San Antonio LID Guidance Manual

SAN ANTONIO LID GUIDANCE MANUAL

**By:
CENTER FOR RESEARCH IN WATER RESOURCES
&
LADY BIRD JOHNSON WILDFLOWER CENTER
UNIVERSITY OF TEXAS AT AUSTIN**

AUGUST 2011

Manual prepared, and financed by grants through, the Texas Commission on Environmental Quality and the United States Environmental Protection Agency as part of the UT LID Workshops project.



Table of Contents

1	Introduction.....	1
1.1	Background & Definition.....	1
1.2	Manual Purpose and Structure	3
1.3	LID Strategies.....	4
1.3.1	Regional, Neighborhood and Site Scale.....	4
1.4	Benefits Provided by LID	5
1.4.1	Environmental Benefits	5
1.4.2	Land Value and Quality of Life Benefits.....	7
1.5	Common terms	9
2	Local Factors Affecting LID Selection in the San Antonio Area	11
2.1	Existing City Code	11
2.2	State Requirements	12
2.3	Geology and Physiographic Regions.....	13
2.3.1	San Antonio Eco-Regions	14
2.4	Brownfield Sites.....	18
2.5	Pollutant Removal.....	19
3	Non-Structural LID Practices.....	20
3.1	Sustainable Site Design	21
3.1.1	Preservation of Natural Features.....	21
3.1.2	Conservation Design	25
3.2	Reduction of Impervious Cover	29
3.2.1	Streets, Sidewalks, Driveways and Parking Lots.....	29
3.3	Disconnection.....	33
3.3.1	Impervious Cover Disconnection.....	33

3.3.2	Downspout Disconnection.....	34
4	Descriptions and Selection Criteria for Structural LID Practices.....	37
4.1	Rain Gardens & Bioretention.....	39
4.1.1	Description.....	40
4.2	Vegetated swales.....	44
4.3	Vegetated Filter Strips.....	47
4.4	Porous Pavement.....	50
4.5	Rainwater Harvesting.....	54
4.6	Treatment Trains.....	57
4.7	Additional LID BMPs	58
4.7.1	Green Roofs.....	58
4.7.2	Proprietary Systems	59
4.7.3	Constructed Wetland & Wet Ponds	60
5	Design Guidelines for Structural LID Practices	62
5.1	Rain Gardens & Bioretention.....	63
5.1.1	Rain Gardens.....	63
5.1.2	Bioretention.....	66
5.1.3	Plant Selection & Considerations.....	75
5.2	Vegetated Swales	79
5.2.1	Plant Selection.....	84
5.3	Vegetated Filter Strips.....	85
5.3.1	Plant Selection.....	89
5.4	Porous Pavement.....	90
6	References.....	92
	Appendix A: Definitions & Acronyms.....	94

Appendix B: Plants96

List of Figures

All figures courtesy of Center for Research in Water Resources and Lady Bird Johnson Wildflower Center unless otherwise noted.

Figure 2-1: Edwards Aquifer Zones and Physiographic Regional Typology (Adapted from CalPoly Studio 606).....	13
Figure 2-2: Typology of Edwards Plateau and Blackland Prairie Regions (Adapted from and courtesy of CalPoly Studio 606).....	15
Figure 3-1: Conventional design (left) and conservation design (right) (courtesy Town of Pine Plains, NY).....	26
Figure 3-2: Disconnection at Portland State University, Oregon, where vegetated areas are distributed throughout the impervious courtyard area.....	33
Figure 3-3: Downspouts directed to permeable pavement on driveway (courtesy of Montgomery County, MD)	34
Figure 3-4: Downspout directed to a rain garden after passing over a stone splash pad.	35
Figure 3-5: Treatment train approach: disconnected downspout runoff enters a series of vegetated controls.	36
Figure 4-1: A diagram of the basic rain garden / bioretention system components, including optional components.	39
Figure 4-2: Picture of a rain garden under construction (courtesy of URS Corporation)	40
Figure 4-3: Picture of a bioretention facility (courtesy of David Dods)	41
Figure 4-4: Schematic of a bioretention/rain garden BMP with no underdrain; treated stormwater infiltrates into surrounding soils.....	42
Figure 4-5: Picture of a typical swale (courtesy of David Dods)	44
Figure 4-6: Swale in parking lot area showing the use of short grasses, low slopes, curb cuts from parking area and some infiltration.....	45
Figure 4-7: Filter strip along side of highway.....	47
Figure 4-8: Picture of permeable pavers in portion of parking lot in San Antonio (courtesy of David Dods).....	50

Figure 4-9: Porous pavement sidewalk installation with filter fabric placed beneath the gravel and stone layers (courtesy of URS Corporation).	51
Figure 4-10: Picture of a rainwater collection system (courtesy of David Dods).....	54
Figure 5-1: Historical rainfall pattern in the Central Texas region and resulting runoff volumes treated.	62
Figure 5-2: An example of a rain garden design following City of Austin specifications as described in Section 1.6.7 of the Environmental Criteria Manual (2009).....	64
Figure 5-3: Rain garden schematic with no underdrain.	65
Figure 5-4: Bioretention along streets with a combination of infiltration and underdrain.	66
Figure 5-5: Schematic diagram of a bioretention system.....	67
Figure 5-6: Curb cut options: smooth cut, hard cut and flush curb.....	68
Figure 5-7: Curb cuts with optional sediment / trash screens	69
Figure 5-8: Detail of cleanout location	71
Figure 5-9: Illustration of optional outlet design	72
Figure 5-10: Diagram of Grassy Swale with Check Dam (MDE, 2000).....	80
Figure 5-11: Enhanced swale diagram with underdrain system in parking lot.....	82
Figure 5-12: Engineered VFS in context.	86
Figure 5-13: Example of filter strip along roadway in plan view.....	87
Figure 5-14: Example configuration of filter strip adjacent to parking lot in plan view..	87
Figure 5-15: Basic components of a porous pavement system.....	90

List of Tables

Table 1: Summary of LID Selection Criteria	37
--	----

1 Introduction

LID is a comprehensive approach to site planning, design and pollution prevention strategies that creates a more economically sustainable and ecologically functional landscape. As such, the LID approach provides many benefits to a community's water resources and overall quality of life.

1.1 Background & Definition

Urban land development tends to increase the intensity of storm water flows and the amount of nonpoint source (NPS) pollution reaching local water resources. Buildings, roads, and other impervious surfaces shed rain more rapidly than areas covered by vegetation, and most typical urban land uses require rapid drainage of storm water. The very rapid, direct connection of developed land across paved surfaces and through drainage conveyances to waterways tends to carry more pollutants more quickly from the land surface to water resources. A number of water quality problems and impairments in Texas are attributed in full or in part to such urban storm water runoff carried through storm sewers and channelized streams.

Low Impact Development (LID) is a comprehensive approach to land development or re-development to manage stormwater runoff. The LID approach:

- Works to maintain and enhance the pre-development hydrologic regime of urban and developing watersheds;
- Works with nature to manage stormwater as close to its source as possible, treating stormwater as a resource rather than a waste product;
- Emphasizes conservation and the use of on-site features to protect water quality;
- Creates functional and appealing site drainage;
- And can reduce construction, maintenance and inspection costs.

LID employs principles such as preserving and recreating natural landscape features, minimizing effective imperviousness, and employing processes of infiltration, filtration, storage, evaporation and detention of stormwater runoff. This manual will describe in detail two methods for reaching these goals, through non-structural and structural practices. Non-structural practices should come first and include practices such as keeping existing trees onsite, minimizing compaction of earth that inhibits water infiltration, and planting trees and other vegetation in areas where none exists. Retaining existing tree cover and vegetated areas helps infiltrate and evapotranspire stormwater runoff while intercepting large amounts of rainfall that would otherwise

enter waterways as runoff. There are many structural practices used to adhere to these principles as well such as bioretention facilities, rain gardens, vegetated rooftops, rainwater harvesting, and permeable pavements. Both structural and non-structural methods are discussed in Chapters 4 and 5.

By implementing LID principles and practices, water can be managed in a way that reduces the impact of built areas and promotes the natural movement of water within an ecosystem or watershed. Applied on a broad scale, LID can maintain or restore a watershed's hydrologic and ecological functions. These principles, and the strategies described below, can be of the most benefit when used together, often in a linked series of practices referred to as the treatment train approach (discussed in detail in Chapter 4).

1.2 Manual Purpose and Structure

This manual is designed to inform designers, developers, policymaker, citizens of San Antonio and others about the benefits and design criteria for implementation of LID practices. This manual will first define what LID is and discuss the myriad of benefits (quantified and anecdotal) derived from the practices. Chapter 2 will discuss certain state and regional issues affecting LID implementation, such as aquifer zones and rules or regulatory compliance. Chapter 3 provides a thorough discussion on non-structural LID practices, often the first and most important step in the LID implementation process. Chapter 4 describes the structural LID practices, including their definition, selection criteria, and maintenance and cost considerations. Chapter 5 provides technical design guidance for LID design and implementation along with specific maintenance and installation requirements.

1.3 LID Strategies

LID strategies are often implemented at three scales: the region or large watershed area, the community or neighborhood, and the site or block. Different stormwater approaches are used at different scales to afford the greatest degree of protection to waterbodies because the influences of pollution are often found at all three scales.

1.3.1 Regional, Neighborhood and Site Scale

At the regional or watershed scale, decisions about where and how to develop are the first, and perhaps most important, decisions related to water quality. Growth and development can give a community the resources needed to revitalize a downtown, refurbish a main street, build new schools, and develop vibrant places to live, work, shop, and play. However, the environmental impacts of development can pose challenges for communities striving to protect their natural resources. Development that uses land efficiently and protects undisturbed natural lands allows a community to grow and still protect its water resources.

Once municipalities have determined where to grow and where to preserve, various stormwater management techniques are applied at the neighborhood or community level. These community scale techniques, such as road width requirements, often transcend specific development sites and can be applied throughout a neighborhood. Finally, site-specific stormwater strategies, such as rain gardens or green roofs, are incorporated within a particular development or on a particular parcel of land.

Of course, some stormwater management strategies can be applied at several scales. For example, opportunities to maximize infiltration can occur at both the neighborhood and site levels. Many smart growth approaches decrease the overall amount of impervious cover associated with a development's footprint. Additional approaches include:

- Directing development to already degraded land;
- Using narrower roads and designing smaller parking lots;
- Integrating retail, commercial, and residential uses; and
- Designing more compact residential lots.

These development approaches, combined with other techniques aimed at reducing the impact of development, can offer communities greater stormwater management.

1.4 Benefits Provided by LID

Future development will continue to create challenges for maintaining and improving water quality in San Antonio's waterbodies. Nationwide, the past few decades of stormwater management have resulted in the current convention of control-and-treatment strategies. These strategies are largely engineered, end-of-pipe practices that have been focused on controlling peak flow rate and suspended solids concentrations. However, these practices fail to address the widespread and cumulative hydrologic modifications within the watershed that increase stormwater volumes and runoff rates, and cause excessive erosion and stream channel degradation. Existing practices also fail to adequately treat for other pollutants of concern, such as nutrients, pathogens, and metals.

The LID approach described above can alleviate some of these challenges posed by development. The following section provides a brief discussion of some of the actual and assumed benefits of LID practices. Note that environmental and ancillary benefits typically are not measured as part of development projects, nor are they measured as part of pilot or demonstration projects, because they can be difficult to isolate and quantify.

1.4.1 Environmental Benefits

Pollution abatement

LID practices can reduce both the volume of runoff and the pollutant loadings discharged into receiving waters. LID practices result in pollutant removal through settling, filtration, adsorption, and biological uptake.

The National Pollutant Removal Database, compiled by the Center for Watershed Protection, is a good resource for examining pollutant removal data from multiple monitoring sites across the country.

Reductions in pollutant loadings to receiving waters also improve habitat for aquatic and terrestrial wildlife and enhance recreational uses. Reducing pollutant loadings can decrease stormwater and drinking water treatment costs by decreasing the need for regional stormwater management systems and expansions in drinking water treatment systems.

Protection of downstream water resources

LID practices can be used to protect water resources that are downstream in the watershed. These practices can help to prevent or reduce hydrologic impacts on receiving waters, reduce stream channel degradation from erosion and sedimentation,

improve water quality, increase water supply, and enhance the recreational and aesthetic value of our natural resources.

Other potential benefits include reduced incidence of illness from contact recreation activities such as swimming and wading, more robust and safer seafood supplies, and reduced medical treatment costs.

Groundwater recharge

LID practices also can be used to infiltrate runoff to recharge ground water. Growing water shortages nationwide increasingly indicate the need for water resource management strategies designed to integrate stormwater, drinking water, and wastewater programs to maximize benefits and minimize costs. Development pressures typically result in increases in the amount of impervious surface and volume of runoff. Infiltration practices can be used to replenish ground water and increase stream baseflow. Adequate baseflow to streams during dry weather is important because low ground water levels can lead to greater fluctuations in stream depth, flows, and temperatures, all of which can be detrimental to aquatic life.

Water quality improvements/reduced treatment costs

Keeping water clean is almost always less expensive than cleaning it up. The Trust for Public Land noted Atlanta's tree cover has saved more than \$883 million by preventing the need for stormwater retention facilities.¹ A study of 27 water suppliers conducted by the Trust for Public Land and the American Water Works Association found a direct relationship between forest cover in a watershed and water supply treatment costs. According to the study, approximately 50 to 55% of the variation in treatment costs can be explained by the percentage of forest cover in the source area. The researchers found that for every 10% increase in forest cover in the source area, treatment and chemical costs decreased approximately 20%, up to about 60% forest cover.² In other words, communities with higher percentages of forest cover had lower treatment costs.

Habitat improvements

Innovative stormwater management techniques like LID or conservation design can be used to improve natural resources and wildlife habitat, or avoid expensive mitigation costs. Conservation design strategies, described in more detail in Section 3.2.3, set aside large parcels of undisturbed land that will not be developed but rather left as open space or as a conservation easement.

¹ The Trust for Public Land. *The Economic Benefits of Land Conservation*. (San Francisco, CA: Trust for Public Land, 2007).

² Trust for Public Land and American Water Works Association. *Protecting the Source* (San Francisco, CA: Trust for Public Land, 2004).

Aquatic habitat improvements can also be seen from LID practices as the quality, volume, rate, and temperature entering receiving waterbodies is more closely associated with pre-development conditions.

1.4.2 Land Value and Quality of Life Benefits

Many of the direct and indirect benefits of LID are derived from improved land value - through improved aesthetics, additional lot yield, or property protection – and quality of life benefits. These latter benefits are some of the most difficult to quantify, yet are also some of the most important for a community as LID techniques can help brand a community, provide multiple amenities, and provide for an improved landscape and sense of place.

Reduced downstream flooding and property damage

LID practices can be used to reduce downstream flooding through the reduction of peak flows and the total amount or volume of runoff. Flood prevention reduces property damage and can reduce the initial capital costs and the operation and maintenance costs of stormwater infrastructure. Strategies designed to manage runoff on-site or as close as possible to its point of generation can reduce erosion and sediment transport as well as reduce flooding and downstream erosion. As a result, the costs for cleanups and streambank restoration can be reduced or avoided altogether. The use of LID techniques also can help protect or restore floodplains, which can be used as park space or wildlife habitat.³

Real estate value/property tax revenue

Homeowners and property owners are willing to pay a premium to be located next to or near aesthetically pleasing amenities like water features, open space, and trails. Some stormwater treatment systems can be beneficial to developers because they can serve as a “water” feature or other visual or recreational amenity that can be used to market the property. These designs should be visually attractive and safe for the residents and should be considered an integral part of planning the development. Various LID projects and smart growth studies have shown that people are willing to pay more for clustered homes than conventionally designed subdivisions. Further, many studies have shown examples where developers and subsequent homeowners have received premiums for proximity to attractive stormwater management practices.⁴

³ The Trust for Public Land. *The Economic Benefits of Land Conservation*. (San Francisco, CA: Trust for Public Land, 2007).

⁴ USEPA, *Economic Benefits of Runoff Controls* (Washington, DC: U.S. Environmental Protection Agency, Office of Water, 1995).

Lot yield

LID practices typically do not require the large, contiguous areas of land that are usually necessary when traditional stormwater controls like ponds are used. In cases where LID practices are incorporated on individual house lots and along roadsides as part of the landscaping, land that would normally be dedicated for a stormwater pond or other large structural control can be developed with additional housing lots.

For more information on the cost-benefits of LID, visit www.texaslid.org for a bibliography of cost-benefit resources and case studies.

Aesthetic value

LID techniques are usually attractive features because landscaping is an integral part of the designs. Designs that enhance a property's aesthetics using trees, shrubs, and flowering plants that complement other landscaping features can be selected. The use of these designs may increase property values or result in faster sale of the property due to the perceived value of the "extra" landscaping.

Public spaces/quality of life/public participation

Placing water quality practices on individual lots provides opportunities to involve homeowners in stormwater management and enhances public awareness of water quality issues. An American Lives, Inc., real estate study found that 77.7 percent of potential homeowners rated natural open space as "essential" or "very important" in planned communities.⁵

⁵ National Park Service, *Economic Impacts of Protecting Rivers, Trails, and Greenway Corridors: A Resource Book* (National Park Service, 1995).

1.5 Common terms

The following Chapters will use several of the terms below as they define the practice and approaches to LID in more detail. Additional terms, such as other unit processes, are defined in Appendix A: Definitions & Acronyms.

Detention

The temporary storage of stormwater runoff (in ponds, underground systems or depressed areas) to allow for controlled discharge at a later time. The outlet structure restricts outflow to pre-development rates.

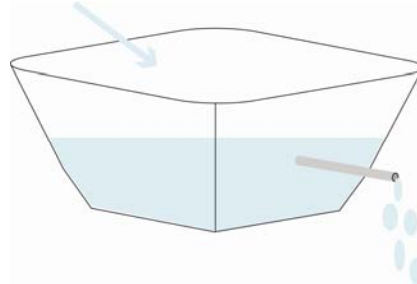

Retention

The storage of stormwater runoff on site and not released at a later time. There is no outlet structure, but retained runoff could be used for an additional purpose such as irrigation.

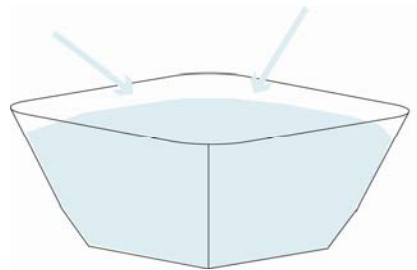

Filtration

The sequestration of sediment and other pollutants from stormwater runoff by the movement of runoff across a vegetated area and through media.

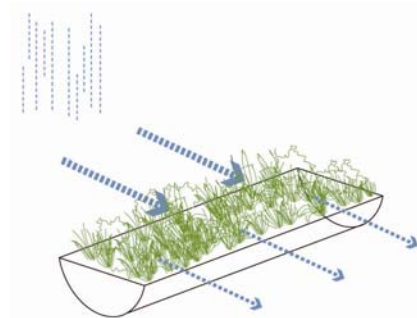

Infiltration

The vertical movement of stormwater through plants and soil; and in unlined systems, recharging groundwater.

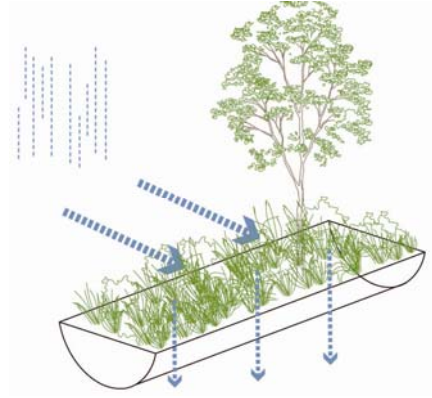

Evapotranspiration

The combined amount of evaporation and plant transpiration from the soil surface or the plant's vascular system to the atmosphere.

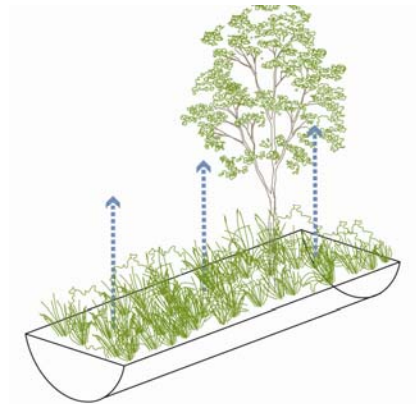

2 Local Factors Affecting LID Selection in the San Antonio Area

2.1 Existing City Code

Among the most important challenges of LID adoption are local codes and ordinances for land development which prohibit or inhibit LID. Existing barriers to LID in city codes are not always intentional. Often barriers exist because codes have not been updated recently to include LID-friendly language. For example, existing city code might have stringent landscape guidelines that preclude the use of LID-appropriate plants. Or, codes might result in the creation of more impervious cover than necessary through street width, parking lot or subdivision regulations. Allowing more flexible design standards can help developers meet the goals and benefits of LID.

Conducting comprehensive reviews of local policies to identify any existing regulatory barriers to the implementation of LID can help address any potential code modifications to accommodate LID. Several tools are available to examine where codified LID roadblocks might exist. A Texas code review tool was developed in 2011 and is available at the TexasLID.org website in the Research and Resources section.

Beyond singular code changes to address LID, which can be time-consuming and burdensome, two other options exist to incorporate LID into regulatory guidance. One option is to provide municipal incentives for LID or other innovative treatment programs. For example, municipalities may allow:

- Increased development densities;
- Reduced review time or expedited review;
- Reduced application fees;
- Flexibility in bulk, height, or dimension restrictions;
- Adjustments to parking requirement;
- Reduced requirements for conventional stormwater management when they use LID techniques;
- Tree canopy credits;
- Reduced size of required drainage infrastructure; or
- Lower stormwater development fees.

A third option is to enact a separate stormwater/LID bylaw; however, a comprehensive review of local codes should happen before writing a bylaw. In all efforts, the emphasis should be on creating a predictable, streamlined process that encourages developers to use LID techniques.

2.2 State Requirements

Currently, the State of Texas regulates stormwater discharges on the Edwards Aquifer Recharge and Contributing zones. The regulations are focused on protection of groundwater quality and generally prohibit the infiltration of stormwater runoff except when the amounts are small (e.g., associated with swales) or when it is applied in a very distributed and redundant manner such as in retention/irrigation systems. Consequently, bioretention systems located on the recharge zone must be lined as described in Chapter 5. Even though the reduction in runoff volume is limited in lined systems, there is still value associated with filtering the stormwater and slowing its discharge. For more information on stormwater guidance over the Edwards Aquifer Recharge and Contributing zones, please see the *Edwards Aquifer Technical Guidance Manual*, also cited in the References section.

2.3 Geology and Physiographic Regions

There are a variety of physiographic regions in San Antonio as the region lies within both the Blackland Prairie and Edwards Plateau eco-regions. These regions differ substantially in geology, soil characteristics, slopes, infiltration rates, and risks of contamination of groundwater from infiltrated runoff from other nearby eco-regions. These eco-regions and their characteristics in the San Antonio area are described below, followed by a section on how these regions will affect LID implementation.

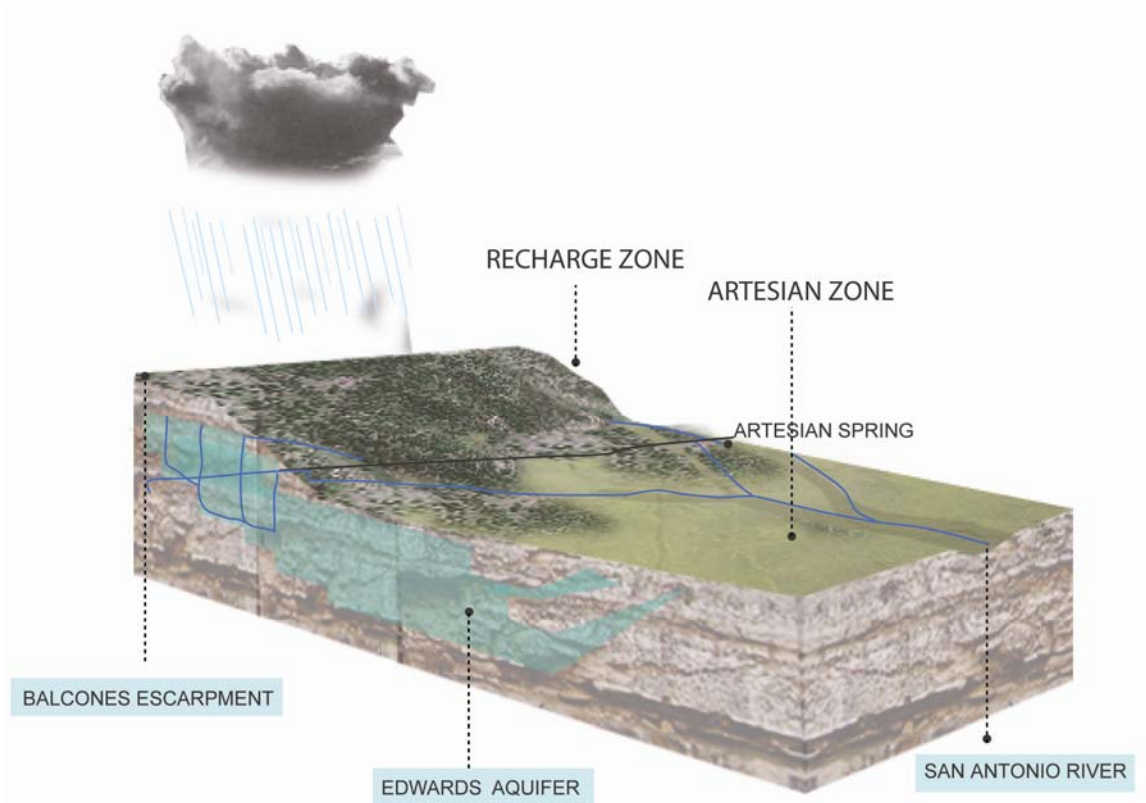

Figure 2-1: Edwards Aquifer Zones and Physiographic Regional Typology (Adapted from CalPoly Studio 606).

2.3.1 San Antonio Eco-Regions

Eco-regions are distinct zones based on the analysis of patterns and composition of characteristics such as geology, physiography, vegetation, climate, soils, land use, wildlife, and hydrology. Of the USDA/EPA 85 Level III eco-regions in the continental United States, two are represented in San Antonio. The geographical juxtaposition of these two distinct eco-regions results in a great diversity of landscapes and species throughout the area and constitutes the iconic Central Texas landscape. Awareness of the characteristics of eco-regions is essential for LID design, success and longevity.

Blackland Prairie Landscape Region

The Blackland Prairie is a part of the Great Plains that once ran from the Waco area along what is now the Interstate 35 corridor to the Red River (Diamond and Smeins 1993). The gently rolling plains of this region possess soils that are mostly fine-textured, dark, calcareous, and productive clays. Historically, the dominant vegetation would have been almost exclusively tallgrass species such as little bluestem, big bluestem, yellow Indiangrass, and tall dropseed with trees and other woody species primarily limited to low lying wet areas and creek and river bottoms. In lowlands and mesic zones, dominant grasses were eastern gamagrass and switchgrass. Stream bottoms were wooded with bur oak, Shumard oak, sugar hackberry, elm, ash, eastern cottonwood, and pecan (Griffith, G.E., et. al., 2004).

It is part of the true prairie ecosystem and as such is dominated by perennial tallgrass species and, in healthy systems, almost entirely lacking trees except along riparian corridors (Riskind and Collins 1975). Researchers have documented at least six distinct vegetative communities making up the Blackland Prairie (Collins et al. 1975). Currently, most of the prairie has been converted to cropland, non-native pasture, and increasingly urban and industrial uses around the larger metropolitan regions such as Dallas, Waco, Austin, and San Antonio. Of the original 15 million acres, less than one percent of the original vegetation still exists and what remains is dispersed throughout the region in small parcels.

Edwards Plateau Landscape Region

The Edwards Plateau eco-region is largely a dissected limestone plateau that is hillier to the south and east where it is easily distinguished from bordering ecological regions by a sharp fault line. Because of the karst topography and underground drainage, the region possesses a network of clear, cool perennial streams. The shallow rocky soils enable both grasses and tree species to become established, forming a region dominated by juniper oak savanna and mesquite-oak savanna, both of which would have had sideoats grama, little bluestem, and muhly grasses commonly in the herbaceous understory. The region was developed through ranching due to the difficulty of the land to plow and is

predominantly used for grazing cattle, sheep, goats, exotic game animals, and native wildlife (Griffith, G.E., et. al., 2004). Today, much of the Edwards Plateau is dominated by poor quality forbs and grasses with juniper woodland being the dominant plant habitat of the region (TPWD).

Edwards Aquifer Zones

The geology of the Edwards Aquifer Contributing and Recharge zones (see Figures 2-1 and 2-2) consist of limestone and alternating limestone/marl sequences of the Edwards and Glen Rose Formations. These are typically overlain by thin soils of the Brackett-Comfort-Real and Comfort-Rumple-Eckrant series. The permeability of the soils and the underlying rocks are frequently quite low. The Transition and Artesian zones of the Edwards Aquifer are generally overlain by substantial thicknesses of younger rocks of the Cretaceous Period and the Blackland Prairie soils. The Blackland soils are thick and have generally low permeability. There are no regulatory restrictions on infiltrating stormwater in the Transition and Artesian zones.

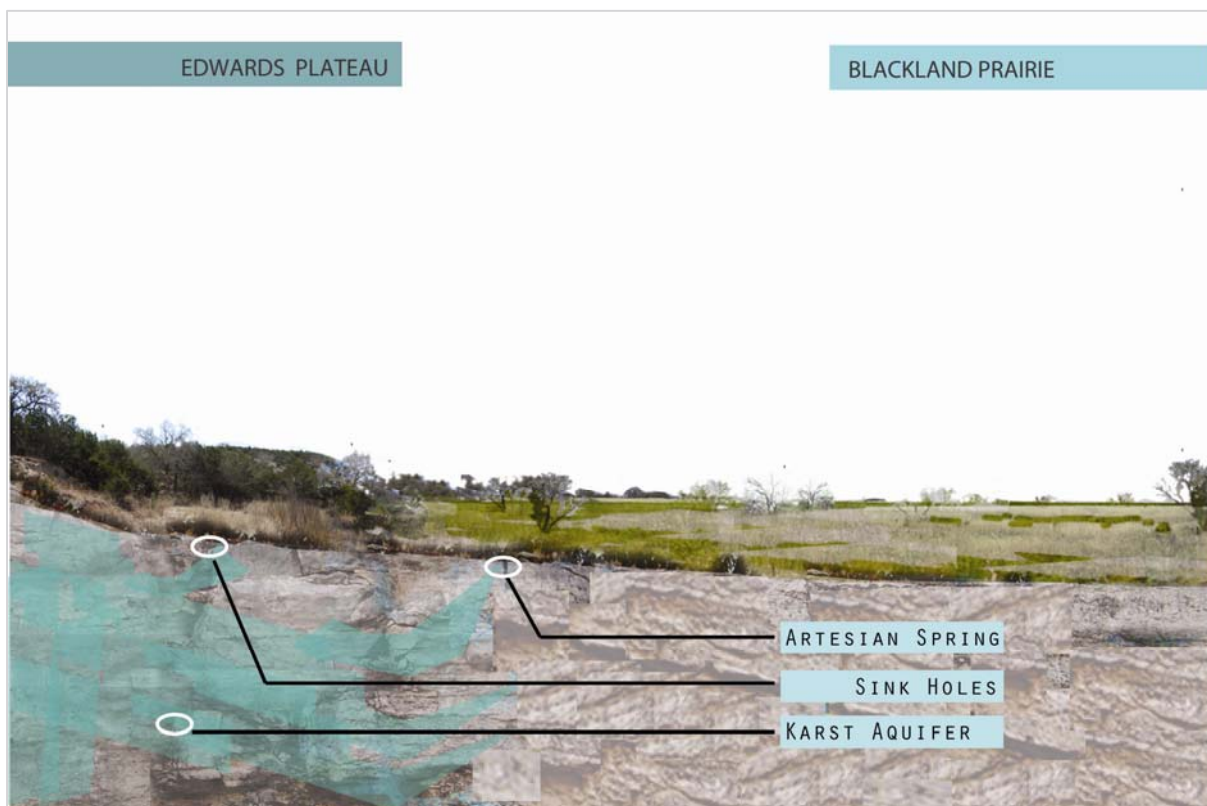

Figure 2-2: Typology of Edwards Plateau and Blackland Prairie Regions (Adapted from and courtesy of CalPoly Studio 606).

Eco-Regions and the Impact on LID Implementation

The eco-regions of the San Antonio area can help inform LID design decisions by placing in context, hydrology, geology, soil types, rainfall patterns, and plant communities. Consideration of the different landscape characteristics assists in items as preliminary as BMP placement or choice, to farther reaching items such as long-term maintenance. For example, residential development in the Edwards Plateau would require minimizing development near karst topography and riparian river crossings due to limited soil layers and steep slopes that increase erosion possibilities and pose a threat to water quality. Additionally, from a regulatory standpoint, implementation of LID in certain portions of the Edwards Plateau will require design modifications as described below. In areas that have more significant soil profiles and gradual slopes such as the Blackland Prairie, infiltration rates will differ from that of the nearby Edwards Plateau eco-region. One way to ensure preservation of San Antonio's waterbodies is to implement non-structural LID practices such as conservation design, preservation of existing resources or disconnection. Further, when using vegetated LID practices, appropriate species selection should also be considered for each of the eco-regions, particularly when using native soils.

Further Consideration for Edwards Aquifer Zones

The karst limestone formations of the contributing and recharge zones are overlain by thin soils. In these areas currently, direct infiltration of stormwater is prohibited per the Edwards Rules. Thus, bioretention and porous pavement facilities must be designed with underdrains. However, the stormwater passing through these systems will still have water quality and peak flow reduction benefits, even though there will be no benefit to groundwater recharge. Controls such as vegetated buffer strips and swales will function effectively and no special design or maintenance efforts will be required in these areas. In areas of steep slopes, LID practices will be difficult to implement but options include terracing of bioretention systems, using rock berms, or other similar treatments. For instance, a series of level bioretention systems down a slope will slow water down and allow it to pond temporarily behind the rock berm before continuing down slope to the next treatment area. In these cases, consideration should be given to the volume and velocity of the flows to assess whether filter fabric or splash pads are necessary.

In the Transition and Artesian zones, infiltration is allowed and there are currently no regulations prohibiting infiltration. Infiltration rates will be lower, which will influence BMP sizing, and in some cases might call for an underdrain. Plant selection is essential in these areas as certain native grasses can help improve infiltration with their deeper root system. Some sites may require modification of the native soils to increase

infiltration rates but the BMP will always be limited by the underlying substrate. In other sites, an underdrain may be necessary under bioretention and porous pavement facilities. Ultimately, BMP designs in these areas will depend on the performance goals for the site. Vegetated buffer strips and swales will function effectively and no special design or maintenance efforts will be required in the Artesian and Transition zones.

Riparian Areas & LID

LID practices along sections of the San Antonio River and Salado Creek, where gravelly sediments deposited by the river have substantial infiltration rates, will prove effective and beneficial. This riparian area allows the maximum performance benefit by both infiltrating all the runoff and eliminating surface discharge. Infiltration rates will vary from site to site, so characterization of the infiltration capacity at the proposed location should be undertaken. However, LID practices in the riparian areas do not need to be structural in nature. Often in these riparian areas the water table can be close to the surface. In this case, healthy (and large, where possible) buffers and strips will be very effective LID practices. The use of infiltration-based LID structural controls higher in the watershed can aid in stream base flow recharge, further helping the success of these riparian areas.

In summary, it is important to understand the local eco-regions in San Antonio before proceeding with LID design and implementation because their characteristics all impact LID implementation. Nevertheless, the full suite of LID practices can be implemented in all areas of San Antonio and will provide substantial benefit for the management of stormwater. Maintenance requirements of LID practices will be the same regardless of the underlying geology or physiographic region. Considering the eco-regions throughout design, construction, and maintenance processes will ensure that LID implementation will be long-lasting, safe, and cost-effective.

2.4 Brownfield Sites

A brownfield is a property, the expansion, redevelopment, or reuse of which may be complicated by the presence or potential presence of a hazardous substance, pollutant, or contaminant. It is estimated that there are more than 450,000 brownfields in the United States. Cleaning up and reinvesting in these properties increases local tax bases, facilitates job growth, utilizes existing infrastructure, takes development pressures off of undeveloped, open land, and both improves and protects the environment.

Preparing brownfields for redevelopment often requires capping of contaminated soils, creating even larger impervious surfaces. The challenge for managing stormwater on brownfield sites is allowing this capping while mitigating the impervious surface conditions that can negatively impact local waterways. Unlike many conventional developments, impervious footprints on brownfields cannot always be minimized through site designs that incorporate more porous surfaces to allow for infiltration. However, LID practices exist that can retain, treat and then release stormwater without it ever coming in contact with contaminated soils.

The first practice is to consider site location within the watershed. New and redeveloped sites near brownfields should use LID practices to prevent additional runoff from flowing onto potentially contaminated areas. By retaining stormwater on site, these sites are preventing runoff from coming in contact with nearby contaminated soils.

The second practice is consideration for the treatment and storage of stormwater, without an infiltration component. Direct infiltration on a brownfield site may introduce additional pollutant loads to groundwater and nearby surface waters. On brownfields that have caps, vegetated areas need to be located above caps and fitted with underdrain systems to direct overflow stormwater to surface drainage. Buildings and other impervious surfaces can be strategically located to act as caps over areas with known contamination. Areas with fill caps can include soils and vegetation above the cap in the form of swales or rain gardens. If fitted with a liner or an underdrain system to prevent infiltration and to release treated stormwater off site, these planted areas can safely allow filtration and evapotranspiration of stormwater. Additional features like impermeable liners or gravel filter blankets can be coupled with modified LID practices that safely filter stormwater without exposing the water to contaminated soils.

2.5 Pollutant Removal

It is common practice for regulatory agencies to adopt stormwater performance standards based on a single constituent, commonly total suspended solids (TSS), to ensure an adequate level of treatment. TSS is a popular choice since it is easily measured, many other pollutants are attached to these solid particles, and it does provide a consistent way to compare a variety of stormwater treatment technologies.

TSS reduction of 85-90% is readily achievable, though it will influence which stormwater systems can be used in a standalone configuration. Treatment systems that rely on infiltration as the primary process for removing solids in stormwater typically achieve a reduction of approximately 90%. The LID practices in this category include bioretention and rain gardens. Other practices that achieve this level of performance, but which are not considered in the LID toolbox, include wet ponds and constructed wetlands. Information on these two practices, including why they are not detailed in this manual, is provided in Section 4.7.

There is also a substantial amount of monitoring data from the Central Texas area indicating that vegetated buffer strips can also achieve this level of pollutant removal when the contributing area is limited and the buffer strip has sufficient width. Swales are not as effective and consequently will be used primarily to convey runoff to or from other LID practices unless they include the optional engineered soil (and underdrain system in areas with less than 0.5 in/hr infiltration rate). For this reason, swales are good techniques to include in treatment trains, discussed further in Section 4.6. These and other BMPs are described in more detail in Chapters 4 and 5.

Pollutant removal and abatement is more readily achievable when LID practices include both media and robust vegetation, rather than just media (such as sand) or a singular plant species. Recent, local research demonstrated that removal of TSS, phosphorous, nitrogen, and fecal coliform from vegetated columns was consistently greatly than from columns with no vegetation.

3 Non-Structural LID Practices

Non-structural practices are often the first step in implementing Low Impact Development. As mentioned, these involve many planning and site design practices such as keeping existing trees onsite, minimizing compaction of soil that inhibits water infiltration, and planting trees and other vegetation in areas where none exists. Once developing on a given site, non-structural practices include simple tools such as disconnection of impervious cover, all of which are discussed in this chapter.

These non-structural practices can:

- Lower a project cost, by reducing elements such as street length and width;
- Increase project yield, by creating more space for development compared with conventional designs; and
- Often require no-cost strategies such as disconnecting a downspout.

The effect of these practices is to reduce the volume of runoff, thereby reducing the size of conveyance systems as well as flood control structures. Consequently, these practices should be implemented to the *maximum extent possible* consistent with local code. This chapter will present several non-structural processes that sites, whether new development or re-development should examine first. These include items such as a conducting a site assessment or strategies for site layout (Section 3.1). It will then follow with guidelines to reduce the impact of the development, including reductions in impervious cover (Section 3.2) or two different disconnection strategies (Section 3.3).

3.1 Sustainable Site Design

Sustainable site design incorporates approaches to new and redevelopment projects which reduce impacts on watersheds by conserving natural areas, and better integrating stormwater treatment. The aim of sustainable site design is to reduce the environmental “footprint” of the site while retaining and enhancing the owner/developer’s purpose and vision for the site. Many of the sustainable site design concepts employ non-structural on-site treatment that can reduce the cost of infrastructure while maintaining or even increasing the value of the property relative to conventional designed developments.

The goals of sustainable site design include:

- Prevent stormwater impacts rather than having to mitigate for them;
- Manage stormwater (quantity and quality) as close to the source as possible and minimize the use of large or regional collection and conveyance;
- Preserve natural areas, healthy soils, native vegetation and reduce the impact on watershed hydrology;
- Use natural drainage pathways as a framework for site design;
- Reduce soil compaction during construction to maintain infiltration capacities of the soil;
- Minimize the amount of disturbance to existing, mature stands of vegetation;
- Utilize simple, non-structural methods for stormwater management that are lower cost and lower maintenance than structural controls;
- Create a multifunctional landscape which considers construction and maintenance implications; and
- Use appropriate plant species and communities for the eco-region and the designed media.

The first series of stormwater site design practices and techniques can be grouped into Preservation of Natural Features and Conservation Design. Discussion of non-structural techniques on site and lot, such as reductions in impervious surface and disconnection, will follow in Sections 3.2 and 3.3. For more in-depth guidance on sustainable site design, please see the Sustainable Sites Initiative www.sustainablesites.org.

3.1.1 Preservation of Natural Features

Preservation of natural features includes techniques to foster the identification and preservation of natural areas that can be used in the protection of water resources. Whether a large contiguous area is set aside as a preservation zone or certain smaller areas have been identified as appropriate for preservation, protecting established

vegetation (existing trees, shrubs, grasses, and other flora) can help reduce revegetation requirements, reduce long-term erosion, preserve habitat, protect water and land resources, and maintain a healthy ecosystem.

Other benefits include:

- An immediate finished “aesthetic” that does not require time to establish;
- Increased stormwater infiltration due to the ability of mature vegetation to process higher quantities of storm water runoff than newly seeded areas;
- Reduced runoff velocity, quantity, and erosion rates (by intercepting rainfall, promoting infiltration, and lowering the water table through transpiration among others);
- Provides a buffer against noise and visual disturbance during construction
- Provides fully developed habitat for wildlife;
- Reduced construction costs; and
- Usually requires less maintenance (e.g., irrigation, fertilizer) and land clearing labor and costs than planting new vegetation.

In order to reach these benefits, it is important to first identify and preserve sensitive areas that affect hydrology. A site assessment is the process whereby the design team conducts an in-depth evaluation of the overall environmental conditions of the proposed development or redevelopment prior to detailed site design. Natural conservation areas are typically identified using mapping and field reconnaissance assessments. Areas proposed for protection should be delineated early in the planning stage, long before any site design, clearing or construction begins.

The goal is to broadly identify and evaluate the ecological systems influencing the area to reduce cost and time impacts from a design, construction and maintenance prospective. Achieving cost reductions is a direct result of a solid understanding of environmental characteristics and integrating the most appropriate construction. The initial design and planning phase is the most appropriate time to conduct the site inventory. For a project which will include LID in San Antonio, items to examine during a site assessment should include:

- Soil types and infiltration rates;
- Health and types of existing vegetation (trees, grasses, shrubs and forbs);
- Land use history and historical vegetation pre-settlement;
- Riparian areas and significant waterways;
- Prominent landforms;
- Site drainage patterns;

- Potential pollution sources;
- Flood plains; and in aquifer zones,
- Any and all karst features including caves or sinkholes.

Identifying these areas can help inform later development as sites should be located to avoid sensitive resource areas such as floodplains, steep slopes, erodible soils, wetlands, mature forests and critical habitat areas. Buildings, roadways, and parking areas should be located to fit the terrain and in areas that will create the least impact.

Floodplains

Development in floodplain areas can reduce the ability of the floodplain to convey stormwater, potentially causing safety problems or significant damage to the site in question, as well as to both upstream and downstream properties. Ideally, the entire 100-year full build out floodplain should be avoided for clearing or building activities, and should be preserved in a natural undisturbed state. If development has already occurred in the floodplain, where possible, future development should stay out of these and other local floodplains.

Once identified, preservation areas should then be incorporated into site development plans and clearly marked on all construction and grading plans to ensure that construction activities are kept out of these areas and that native vegetation is kept in an undisturbed state. The boundaries of each conservation area should be mapped by carefully determining the limit which should not be crossed by construction activity.

Slopes

Development on slopes with a grade of 15% (7:1) or greater should be avoided, if possible to limit soil loss, erosion, excessive stormwater runoff, and the degradation of surface water. Excessive grading should be avoided on all slopes, as should the flattening of hills and ridges. Steep slopes should be kept in an undisturbed natural condition to help stabilize hillsides and soils. On slopes greater than 25% (4:1), no development, re-grading, or stripping of vegetation should be considered.

Soils

Areas of a site with hydrologic soil group A and B soils, such as sands and sandy loam soils, should be conserved as much as possible and these areas should ideally be incorporated into undisturbed natural or open space areas. Conversely, buildings and other impervious surfaces should be located on those portions of the site with the *least* permeable soils. Similarly, areas on a site with highly erodible or unstable soils should be avoided for land disturbing activities and buildings to prevent erosion and sedimentation problems as well as potential future structural problems. These areas should be left in an undisturbed and vegetated condition.

Buffers

A riparian buffer is a special type of natural conservation area along a stream, wetland or shoreline where development is restricted or prohibited. The primary function of buffers is to protect and physically separate these waterbodies from future disturbance or encroachment. If properly designed, a buffer can provide stormwater management functions, can act as a right-of-way during floods, and can sustain the integrity of water resource ecosystems and habitats.

Riparian buffers should be continuous and not interrupted by impervious areas that would allow stormwater to concentrate and flow into the stream without first flowing through the buffer. Existing forested riparian buffers should be maintained. Where no wooded buffer exists, reforestation should be encouraged. Proper restoration should include all layers of the forest plant community, including trees, understory, shrubs and groundcover.

The buffer width needed to perform properly will depend on the size of the stream and the surrounding conditions, but a minimum 25-foot undisturbed vegetative buffer is needed for all waterbodies, even the smallest perennial streams. This first 25' section should be a zero development zone and should contain restrictions on the types of the uses and vegetation in this zone. Beyond the 25' section, an additional 50' or larger undisturbed buffer is ideal. Additional zones can be added to extend the total buffer to at least 100 feet from the edge of the stream. Some streams and watersheds may benefit from additional measures to ensure adequate protection. In some areas, specific state laws or local ordinances already require stricter buffers than are described here. Some regions, including Austin, use catchment area to determine size of buffer as described below:

- Streams draining 640 acres (one square mile) or greater should have a minimum buffer of 300 feet from the centerline on each side of the stream.
- Streams draining less than 640 acres but 320 or more acres should have a minimum buffer of 200 feet from the centerline on each side of the stream.
- Streams draining less than 320 acres but 128 or more acres should have a minimum buffer of 100 feet from the centerline on each side of the stream.
- Streams or swales draining less than 128 acres but 40 or more acres should have a minimum buffer of 50 feet from the centerline on each side of the drainage.
- Streams or swales draining less than 40 acres but 5 or more acres should have a minimum buffer of 25 feet from the centerline on each side of the drainage.

Where feasible, riparian buffers should be sized to include the 100-year floodplain as well as steep banks and freshwater wetlands. The development of LID features within

the buffer zone should be allowed within the 25-75' buffer zone as long as the development does not adversely impact the riparian area.

Development within the larger riparian buffer (beyond 50') should be limited only to those structures and facilities that are absolutely necessary. Such limited development should be specifically identified in any codes or ordinances enabling the buffers. When construction activities do occur within the riparian corridor, specific mitigation measures should be required, such as deeper buffers or riparian buffer improvements.

Ideally, all buffers should remain in their natural state. However, some maintenance is periodically necessary, such as:

- Planting to minimize concentrated flow;
- Removal of invasive or exotic plant species when these species are detrimental to the vegetated buffer; and
- Removal of diseased or damaged trees.

Construction & Maintenance Considerations

Once a site is under construction, minimal disturbance methods should be used to limit the amount of clearing and grading that takes place on a development site, preserving the undisturbed vegetation and natural hydrology of a site. A limit of disturbance (LOD) should be established based on the maximum disturbance zone. These maximum distances should reflect reasonable construction techniques and equipment needs together with the physical situation of the development site such as slopes or soils. LOD distances may vary by type of development, size of lot or site, and by the specific development feature involved.

Not only should these natural conservation areas be protected during construction, but they should also be managed after occupancy by a responsible party able to maintain the areas in a natural state in perpetuity. Typically, conservation areas are protected by legally enforceable deed restrictions, conservation easements, and a maintenance agreement.

3.1.2 Conservation Design

For the purposes of this document, conventional design can be viewed as the style of suburban development that has evolved over the past 50 years and generally involves larger lot development, clearing and grading of significant portions of a site, wider streets and larger cul-de-sacs, enclosed drainage systems for stormwater conveyance, and large “hole-in-the-ground” detention basins (see left image of Figure 3-1).

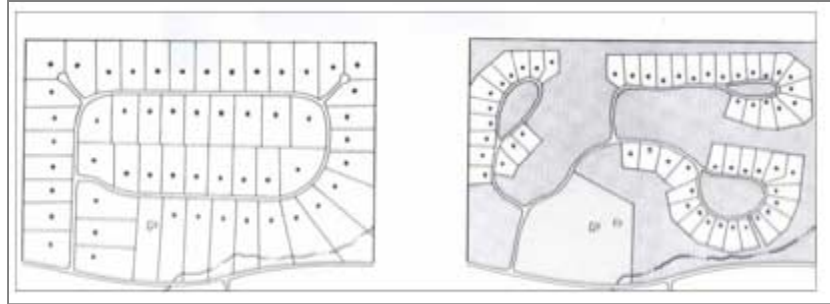

Figure 3-1: Conventional design (left) and conservation design (right) (courtesy Town of Pine Plains, NY).

Conservation design, also known as open space design or cluster development, includes laying out the elements of a development project in such a way that the site design takes advantage of a site's natural features, preserves the more sensitive areas, and identifies any site constraints and opportunities to prevent or reduce impacts. Techniques include:

- Preservation of undisturbed areas;
- Preservation of stream buffers;
- Reduction in clearing and grading;
- Locating projects in less sensitive areas; and
- Clustering development.

As mentioned in Section 3.1.1, these natural conservation areas are typically identified through a site assessment. Depending on the site, an assessment can be performed by professionals on the project development team (engineers, landscape architects or planners for example); however, to fully examine a site and its ecological conditions which will influence BMP design, more in-depth site analysis should be done by hydrologists, ecologists, biologists or others professionals with site assessment experience in order to test infiltration rates, asses soil type and quality, and be able to properly identify existing vegetation. In many cases, a geotechnical report may also be required to assess depth to groundwater among other factors. When done before the concept plan phase, the planned conservation areas, and identification of other sensitive features also outlined above, can then be used to guide the layout of a project. For more guidance on conducting a site assessment, visit the Sustainable Sites Initiative™ guidelines⁶.

⁶ www.sustainablesites.org

Conservation subdivisions typically incorporate smaller lot sizes to reduce overall impervious cover while providing more undisturbed open space and protection of water resources. This approach concentrates structures and impervious surfaces in a compact area in one portion of the development site in exchange for providing open space and natural areas elsewhere on the site. Typically smaller lots and/or nontraditional lot designs are used to cluster development and create more conservation areas on the site.

Conservation developments have many benefits compared with conventional commercial developments or residential subdivisions. They can reduce:

- Impervious cover;
- Stormwater pollution;
- Construction costs; and
- Reduce the need for grading and landscaping, while providing for the conservation of natural areas.

Along with reduced imperviousness, which carries multiple ancillary benefits as mentioned above, conservation designs provide a host of other environmental benefits lacking in most conventional designs. They can prevent encroachment on conservation and buffer areas. They create community-wide interconnected network of protected meadows, fields and woodlands. They can help to provide habitat, and protect farmland and other natural resources while allowing for the maximum number of residences under current community zoning. As less land is cleared during the construction process, alteration of the natural hydrology and the potential for soil erosion are also greatly diminished. Perhaps most importantly, open space design reserves 25 to 50% of the development site in conservation areas that would not otherwise be protected.

Conservation developments can also be significantly less expensive to build than conventional projects. Most of the cost savings are due to reduced infrastructure cost for roads and stormwater management controls and conveyances. Further, developers find that these properties often command higher prices than those in more conventional developments. Several studies estimate that residential properties in open space developments garner premiums that are higher than conventional subdivisions and moreover, sell or lease at increased rates.

Once established, common open space and natural conservation areas must be managed by a responsible party able to maintain the areas in a natural state in perpetuity. Typically, the conservation areas are protected by legally enforceable deed restrictions, conservation easements, and maintenance agreements.

Preservation of natural areas and conservation designs can help to preserve pre-development hydrology of the site and aid in reducing stormwater runoff and pollutant

load. Undisturbed vegetated areas also promote soil stabilization and provide for filtering and infiltration of runoff. Maintaining existing vegetation can be particularly beneficial to sites with floodplains, wetlands, stream banks, steep slopes, critical environmental features, or where erosion controls are difficult to establish, install, or maintain.

3.2 Reduction of Impervious Cover

Once a development or redevelopment site has completed a site assessment to identify all the features mentioned above and the initial planning and design phase has begun, there are several additional non-structural LID tools to implement: reduce total impervious cover and disconnect.

Reduction of impervious cover includes methods to reduce the amount of rooftops, parking lots, roadways, sidewalks and other surfaces that do not allow rainfall to infiltrate into the soil, in order to reduce the volume of stormwater runoff, increase groundwater recharge, and reduce pollutant loadings that are generated from a site.

Most municipalities agree that an increase in impervious cover will increase runoff. However, the degree to which this is true is a function of several factors such as soil type, rainfall intensity, flow path and the amount of connected impervious cover among others. Thus, the effectiveness of disconnection practices – directing gutter downspouts into vegetated areas or disconnecting pavement – can be difficult to quantify. Therefore, many municipalities may not give any credit for these types of activities, even though there is obviously some benefit. The following section describes techniques to reduce overall impervious cover, and methods to disconnect existing or proposed impervious areas to maximize the benefit of LID.

3.2.1 Streets, Sidewalks, Driveways and Parking Lots

Streets

The first step in achieving a reduction in impervious cover for streets is by examining street lengths and widths. The use of alternative road layouts that reduce the total linear length of roadways can significantly reduce overall imperviousness of a development site. Site designers are encouraged to analyze different site and roadway layouts to see if they can reduce overall street length. Streets should be designed for the minimum required pavement width needed to support travel lanes, on-street parking, and emergency access. Several design options exist to reduce the total length and width of streets:

- One-way single-lane loop roads can reduce the width of lower traffic streets;
- On-street parking can be reduced to one lane or eliminated on local access roads with less than 200 average daily trips (ADT), and on short cul-de-sac streets;
- Reducing side yard setbacks and using narrower frontages can reduce total street length, which is especially important in Conservation Designs (Section 3.1).

Another large opportunity to reduce impervious cover on streets is with alternative turnaround areas, such as cul-de-sac design. Many of these cul-de-sacs can have a radius of more than 40 feet. From a stormwater perspective, cul-de-sacs create a huge bulb of impervious cover, increasing the amount of runoff. For this reason, reducing the size of cul-de-sacs through the use of alternative turnarounds or eliminating them altogether can reduce the amount of impervious cover created at a site. Alternative design options include:

- Reducing cul-de-sacs to a 30-foot radius;
- Allowing hammerheads as an alternative cul-de-sac form;
- Creating pervious islands in the center of the cul-de-sac;
- Including LID features in the center of the cul-de-sac such as bioretention areas to capture and treat runoff from the circular pavement; or
- Eliminating turnarounds altogether and building loop roads. and pervious islands in the cul-de-sac center.

Sufficient turnaround area is a significant factor to consider in the design of these cul-de-sacs. For example, fire trucks, service vehicles and school buses are often cited as needing large turning radii. However, some fire trucks are designed for smaller turning radii. In addition, many newer large service vehicles are designed with a tri-axle (requiring a smaller turning radius) and many school buses usually do not enter individual cul-de-sacs.

Another option for designing cul-de-sacs involves the placement of a pervious island in the center. Vehicles only travel along the outside of the cul-de-sac when turning, leaving an unused “island” of pavement in the center. These islands can be attractively landscaped and also designed as bioretention areas to treat stormwater.

Sidewalks

Most codes require that sidewalks be placed on both sides of residential streets (e.g. double sidewalks) and should be constructed of impervious concrete or asphalt. Many subdivision codes also require sidewalks to be 4 to 6 feet wide and 2 to 10 feet from the street. These codes are enforced to provide sidewalks as a safety measure. However, San Antonio should consider several alternative sidewalk designs.

- One, allow sidewalks on only one side of the street or eliminating them where they are not needed such as in low-density areas.
- Two, allow reductions in sidewalk widths and their placement further from the street. The added space in between the street and sidewalk is an ideal location to place LID practices to capture runoff from the road.
- Three, allow sidewalks to be graded to drain to front yards, or vegetated areas between the sidewalk and the street, rather than the street.

- Four, allow alternative surfaces for sidewalks and walkways, such as pervious pavements, to reduce total impervious cover.
- Five, allow a reduction in sidewalk requirements if developers include alternative pedestrian networks, such as trails.
- Lastly, building and home setbacks should be shortened to reduce the amount of impervious cover from entry walks.

Providing a landscaped area between sidewalks and the streets will also provide substantial opportunity for stormwater infiltration.

Driveways & Setbacks

Typical residential driveways range from 12 feet wide for one car to 20 feet wide for two. There are several alternative driveway designs developers should be allowed to implement which help reduce impervious cover and these include:

- Shared driveways: can reduce impervious cover and should be encouraged with enforceable maintenance agreements and easements;
- Narrower driveway widths and lengths: the typical 400-800 square feet of impervious cover per driveway can be minimized by using narrower driveway widths or reducing the length of driveways;
- Alternative design such as double-tracks; or
- Alternative surfaces such as reinforced grass, or permeable paving materials.

Building and home setbacks should be shortened to reduce the amount of impervious cover from driveways and entry walks. A setback of 20 feet is more than sufficient to allow a car to park in a driveway without encroaching into the public right of way, and reduces driveway and walk pavement by more than 30% compared with a setback of 30 feet.

Parking

Many parking lot designs result in far more spaces than actually required. This problem is exacerbated by a common practice of setting parking ratios to accommodate the highest hourly parking during the peak season. This is often the case with minimum parking standards which are often set to accommodate the highest hourly parking demand for the particular site and use. However, these minimum parking standards often result in more spaces than are required to meet demand as the language provides flexibility for the designer and developer to provide additional parking spaces beyond the minimum resulting in excess levels of parking. Setting parking standards as a maximum can ensure that sufficient parking is established to meet the demand without creating excess spaces.

There are many options available to reduce the overall parking footprint and site imperviousness. First steps include determining average parking demand and the lot location. A lower maximum number of parking spaces can be set to accommodate most of the demand. The number of parking spaces needed may be reduced by a site's accessibility to public transportation. Additional design strategies include:

- Setting maximums for parking spaces rather than minimums;
- Minimizing stall dimensions (by reducing both the length and width of the parking stall);
- Requiring a certain number of spaces be sized for compact vehicles;
- Using structured parking (which can reduce the conversion of land to impervious cover);
- Incorporate efficient parking lanes such as utilizing one-way drive aisles with angled parking rather than the traditional two-way aisles;
- Encouraging shared parking, particularly in mixed-use areas and for non-competing parking lot users; and
- Using alternative porous surfaces.

Utilizing alternative surfaces such as porous pavers or porous concrete is an effective way to reduce the amount of runoff generated by parking lots. They can replace conventional asphalt or concrete in both new development and redevelopment projects.

3.3 Disconnection

Disconnection of impervious surfaces and downspouts is encouraged to maximize the function of the LID practices. Disconnection is a low-cost, effective non-structural control which can reduce total runoff volume, increase the time of concentration and promote infiltration. The first step in disconnection is to identify the source of runoff and understand how it will be managed once disconnection occurs. In addition, well-conceived use of disconnection methods can reduce overall project costs by reducing or eliminating the need for more expensive structural practices.

3.3.1 Impervious Cover Disconnection

Although the amount of impervious cover on a site can be minimized, it is unrealistic to think it can be eliminated completely. Despite this, impervious areas do not necessarily have to contribute to the runoff leaving the site. The amount of runoff and associated pollutants from a project can be reduced by disconnecting impervious surfaces. By disconnecting impervious areas and directing the flow to infiltration basins or designated buffer areas, a portion of additional runoff that would contribute to stormwater runoff is infiltrated close to the source instead. Further, the runoff that would potentially carry pollutants from the site to surface water instead gets treated and helps recharge groundwater.



Figure 3-2: Disconnection at Portland State University, Oregon, where vegetated areas are distributed throughout the impervious courtyard area.

Disconnection methods should be incorporated at the planning and design level. However, the designer and reviewer should note that these methods must be used in concert with the design of other stormwater conveyance and treatment practices. The use of these disconnection methods does not relieve the designer or reviewer from following the standard engineering practices associated with safe conveyance of stormwater runoff and good drainage design.

3.3.2 Downspout Disconnection

Rooftops with exterior drains for the gutter (the normal configuration for most residential structures) is one of the easiest disconnection practices to implement. These downspouts should be directed to landscaped portions of the site rather than driveways or sidewalks unless the driveway is constructed of pervious paving materials as shown in Figure 3-3. It is not common, but driveways can be crowned so that a portion of the runoff is directed to vegetated areas, rather the street.



Figure 3-3: Downspouts directed to permeable pavement on driveway (courtesy of Montgomery County, MD)

In addition to directing downspouts to vegetated areas, roof runoff may also be directed to cisterns and other rain barrels for later consumption, or even to depressed storage or other underground storage areas. Further, this runoff may be directed through a treatment train system as described below and demonstrated in Figure 3-6. Some design considerations include:

- Slowing down the water after it leaves the downspout if the volume and velocity is high (as shown with a splash pad configuration in Figure 3-4);
- Keeping the disconnected runoff away (10' minimum) from other impervious surfaces to reduce the chance for re-connection;

- Not placing the disconnected runoff into a steep slope area which could cause erosion and concentrate flows; and
- Directing the runoff into features specifically designed to receive (and either store, soak, treat, or convey) this runoff.



Figure 3-4: Downspout directed to a rain garden after passing over a stone splash pad.

In Figure 3-4 above, this downspout disconnection is part of a larger treatment train system, as disconnection techniques often are. Once the rooftop runoff is directed into splash pad area, it flows off the side into a bioretention system pictured in Figure 3-5 below. Excess water not infiltrated or evaporated enters the overflow grate shown in the bottom left of the middle image. From here, the runoff is carried away from the building underneath the sidewalk and into a second treatment area, a larger bioretention system adjacent to the parking lot, shown at right.



Figure 3-5: Treatment train approach: disconnected downspout runoff enters a series of vegetated controls.

For more information on sustainable site design practices, see the Sustainable Sites Initiative (SITES™).⁷

⁷ www.sustainablesites.org

4 Descriptions and Selection Criteria for Structural LID Practices

The following sections describe a variety of structural LID practices that can be used to convey, treat, and infiltrate stormwater runoff. This chapter will describe the following practices in detail:

- Rain Gardens & Bioretention
- Vegetated Swales
- Vegetated Filter Strips
- Porous Pavement
- Rainwater Harvesting

Though the LID toolbox is unlimited, this manual focuses on the above structural tools as they are most appropriate for the San Antonio region. Further, many of these practices are most effective at reducing both runoff volume and pollutant loads. Section 4.7 at the end of this chapter discusses several other structural controls in brief, such as green roofs and proprietary systems, and provides links to resources for more information if projects wish to implement these practices. A quick summary of the selection criteria, described in detail below, is provided in Table 1 below.

Table 1: Summary of LID Selection Criteria

LID BMP	Benefit	Maintenance	Cost
Bioretention and Rain Gardens	Slows runoff, filters pollutants, can detain or retain runoff, provides for ET, has numerous water quality benefits, and the design is flexible	Low to High depending on location and design	Low to High depending on location and design
Vegetated Swales	Slows runoff, conveys runoff and provides some filtration, detains water, provides some water quality and ET benefit	Low	Low to Medium

Vegetated Filter Strip	Slows runoff, provides some filtration, detains water, provides pollutant removal and ET benefit	Low	Low
Porous Pavement	Slows runoff and provides some filtration, detains or retains water depending on design, provides for evaporation	Low	High
Rainwater Harvesting	Provides some water quality benefit because it captures the first flush, detains and retains water, water conservation, runoff volume reduction	Low	Medium to High

4.1 Rain Gardens & Bioretention

The rain garden and bioretention best management practices function as a soil and plant-based filtration device that removes pollutants through a variety of physical, biological, and chemical treatment processes. These facilities normally consist of a filtration bed, ponding area, organic or mulch layer, and plants. Figure 4-1 illustrates the basic components of the system.

Rain gardens and bioretention systems are very similar BMPs in their design and function. Both systems can be used in any land use type or for any site. For the purposes of this manual, the main difference between the two systems is that a bioretention system uses engineered soils. While rain gardens do not include engineered soils, they can include slightly modified soils. Both systems can be designed with or without underdrains or liners. (Circumstances where underdrains or liners would be required are described in Section 5.1.)

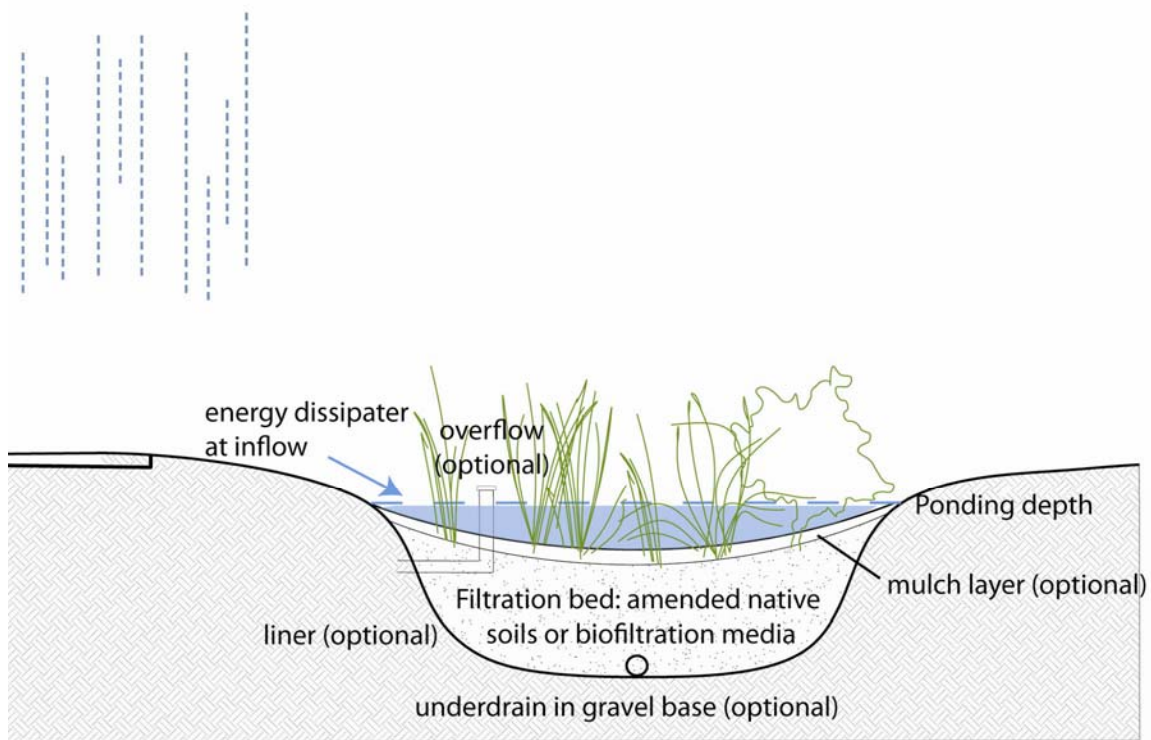

Figure 4-1: A diagram of the basic rain garden / bioretention system components, including optional components.

4.1.1 Description

A rain garden is a landscaped area in a basin shape designed to capture runoff and settle and filter out sediment and pollutants, primarily from rooftops, driveways, sidewalks, parking lots, and streets. Swales with check dams or berms that allow water to back up behind them function like rain gardens, and flow-through planters have also been described as a series, or treatment train, of rain gardens. What they all have in common is that they allow water to be retained in an area with plants and soil where the water is allowed to pass through the plant roots and the soil column.

In general, there are two kinds of rain gardens. Filtration rain gardens cleanse and detain stormwater runoff. Because they are specifically lined or have an underdrain to prevent infiltration in some areas (in areas where the influent is deemed too pollutant-heavy or for other site constraints) they don't significantly reduce stormwater volumes. However, these systems still provide substantial pollutant removal and increase the time of concentration. Infiltration rain gardens cleanse, detain and reduce runoff volumes by allowing water to seep into the surrounding soils.

Rain gardens are constructed with native soils (often with amendments), rather than the engineered media used in bioretention systems. In addition, they are designed with shallow ponding depths that are adjusted to the infiltration capacity of the soil to ensure timely absorption of the water and as mentioned above, do not always include underdrains in their design. Otherwise, the selection criteria and limitations are the same as bioretention systems described below. A rain garden under construction is presented in Figure 4-2.



Figure 4-2: Picture of a rain garden under construction (courtesy of URS Corporation)

Bioretention areas are similar to rain gardens except that they contain an engineered media mix. A picture of a bioretention system located in a parking lot island is presented in Figure 4-3.



Figure 4-3: Picture of a bioretention facility (courtesy of David Dods)

In areas of San Antonio with thin layers of topsoil over shallow limestone, bioretention could be a lined, more linear filtration system to remove pollutants before being released to streams. This alternative design could be a shallower system with a larger surface area.

Infiltration of the stored water in the bioretention system into the underlying soils occurs over a period of days when installed without an underdrain system. Figure 4-4 shows an example of a rain garden or bioretention system with no liner, where filtered water infiltrates into the surrounding native soils.

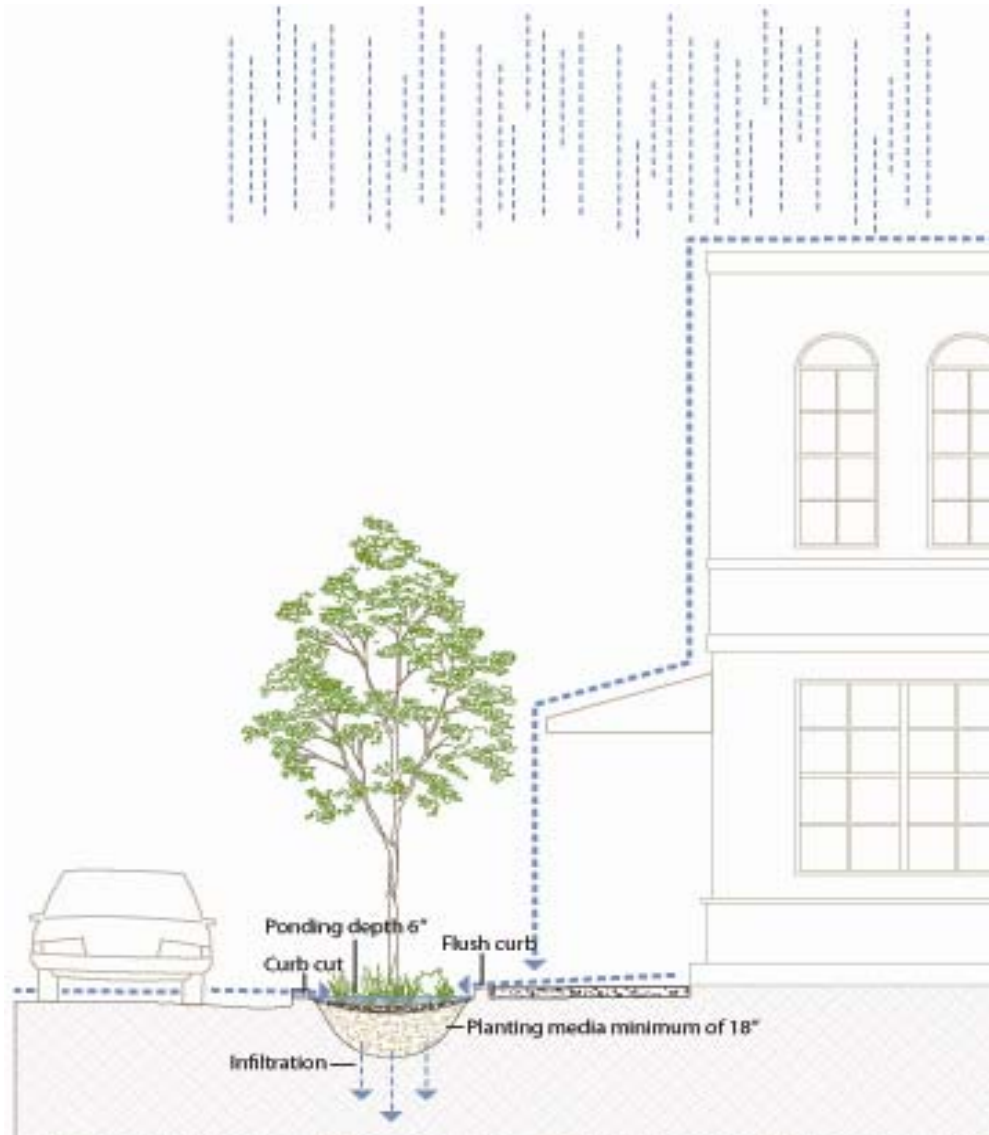

Figure 4-4: Schematic of a bioretention/rain garden BMP with no underdrain; treated stormwater infiltrates into surrounding soils.

Selection Criteria

- Good choice of an onsite system serving a relatively small drainage area, since it can be incorporated into the site landscaping;
- Bioretention provides stormwater treatment that enhances the quality of downstream water bodies by temporarily storing runoff and releasing it over a period of days to the receiving water;
- The vegetation provides shade and wind breaks, and absorbs noise;
- Improves an area's landscape and has many aesthetic benefits;

- One advantage to rain gardens is that these are slightly simpler systems that can be easily implemented without the need for special training making them a good BMP for homeowners to implement on their own property;
- Rain gardens and bioretention features are easily integrated into site landscaping; and
- Their design can be formal or informal in character.

Limitations

- Bioretention can be difficult in areas with slopes greater than 20% (5:1). Bioretention systems need to be level for optimal filtration so in locations with slopes greater than 20%, they should be terraced. One option of an alternative design for these areas would be to construct a series of bioretention systems in a terraced design with check dams at regular intervals;
- Bioretention can be difficult where mature tree removal would be required since clogging may result, particularly if the facility receives runoff with high sediment loads;
- Unlined bioretention systems are not suitable at locations where the water table is within 6 feet of the ground surface and where the surrounding soil stratum is unstable; and
- Inclusion of substantial amounts of compost in the filter media can substantially increase nutrients in the discharge. Organic matter needs to be used in limited amounts and of high-quality, low-nutrient composition.

Cost Considerations

The major costs associated with bioretention systems are the soil mixture and plants. The costs are greater than those for landscaping alone; however, the water quality benefits are substantial. The use of underdrains and liners will also increase the cost versus bioretention systems designed for infiltration.

4.2 Vegetated swales

Grassy swales are vegetated channels that convey stormwater and remove pollutants by sedimentation and infiltration through soil. They require shallow slopes and soils that drain well. Pollutant removal capability is related to channel dimensions, longitudinal slope, and amount of vegetation. Optimum design of these components will increase contact time of runoff through the swale and improve pollutant removal rates.

Grassy swales are primarily stormwater conveyance systems. They can provide sufficient control under light to moderate runoff conditions, but their ability to control large storms is limited. Therefore, they are most applicable in low to moderate sloped areas or along highway medians as an alternative to ditches and curb and gutter drainage. Grassy swales can be used as a pretreatment measure for other downstream facilities, such as bioretention areas. Enhanced grassy swales utilize engineered soils and an underdrain to provide filtration of pollutants. A picture of a grassy swale is presented in Figure 4-5.

Grassy swales can be more aesthetically pleasing than concrete or rock-lined drainage systems and are generally less expensive to construct and maintain. Swales can slightly reduce impervious area and reduce the pollutant accumulation and delivery associated with curbs and gutters. The disadvantages of this technique include the possibility of erosion and channelization over time, and the need for more right-of-way as compared to a storm drain system.



Figure 4-5: Picture of a typical swale (courtesy of David Dods)

Selection Criteria

- Pretreatment for other LID practices
- Limited to treating a few acres
- Availability of water during dry periods to maintain vegetation
- Sufficient available land area

The suitability of a swale at a site will depend on land use, size of the area serviced, soil type, slope, and dimensions and slope of the swale system. In general, swales can be used to convey runoff from areas of less than 2 acres, with slopes no greater than 5 % (20:1). Research in the Central Texas area indicates that vegetated controls are effective at removing pollutants even when dormant. Therefore, irrigation is not required to maintain growth during dry periods, but may be necessary only to prevent the vegetation from dying. An example of a swale for a parking lot area is shown in Figure 4-6.

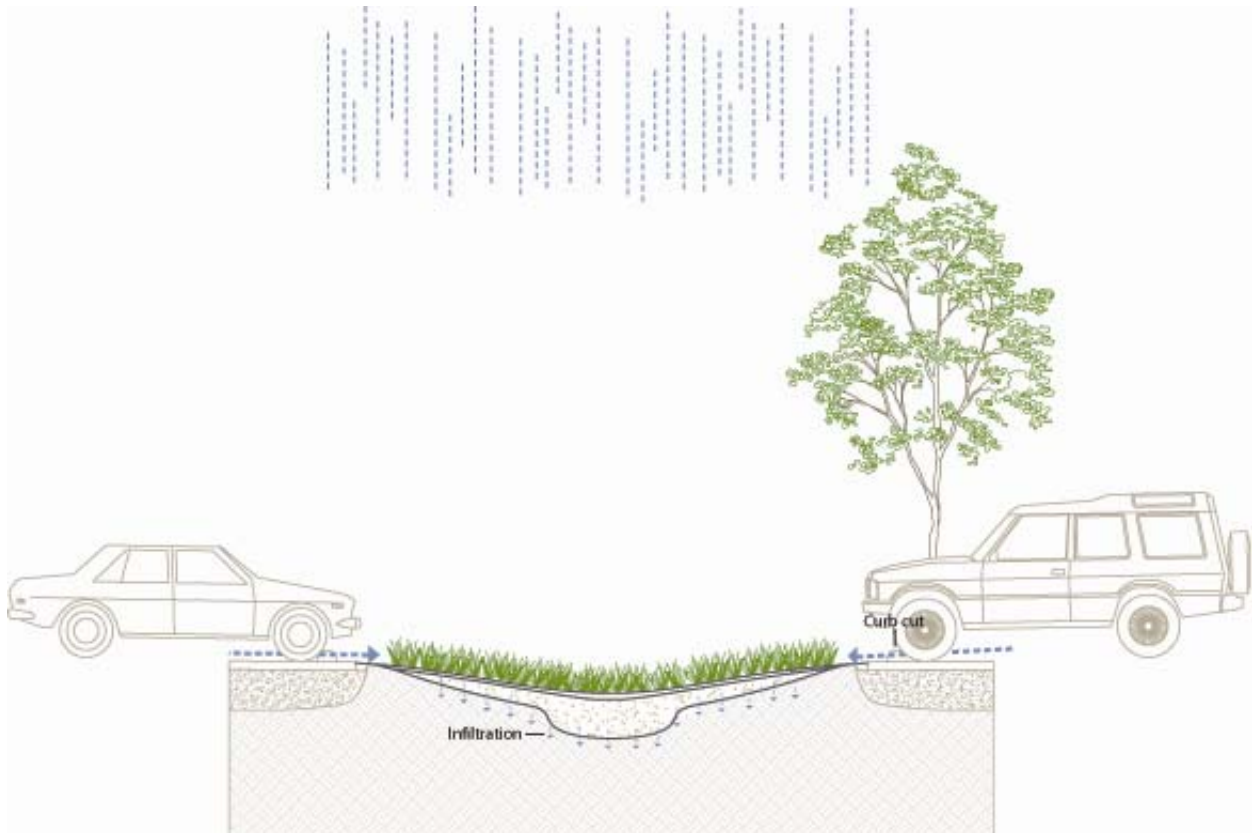

Figure 4-6: Swale in parking lot area showing the use of short grasses, low slopes, curb cuts from parking area and some infiltration.

Limitations

- Can be difficult to avoid channelization;
- Cannot be placed on steep slopes; and
- Area required may make infeasible on intensely developed areas.

The topography of the site should permit the design of a channel with appropriate slope and cross-sectional area. Site topography may also dictate a need for additional structural controls since the maximum recommended longitudinal slope is about 2.5% (40:1). Flatter slopes can be used, if sufficient to provide adequate conveyance. Steep slopes increase flow velocity, decrease detention time, and may require energy dissipation and grade check. Steep slopes also can be managed using a series of check dams to terrace the swale and reduce the slope to within acceptable limits. The use of check dams with swales also promotes infiltration.

Cost Considerations

A swale is a lower-cost, alternate form of conveyance that provides some treatment and so has both a cost benefit and a water quality benefit when compared with curb and gutter or pipe drainage systems. Enhanced swale systems will cost more than a grassy swale due to the addition of certain components for enhanced treatment capacity. Both types of swales are described in more detail in Section 0.

4.3 Vegetated Filter Strips

Vegetated Filter Strips (VFS), also known as filter strips or vegetated buffer strips, are a moderate to low-cost method for improving the quality of storm water runoff by using biological and chemical processes in soil and vegetation to filter out pollutants from runoff flowing through it as sheet flow. VFS are similar to grassy swales except that they are essentially flat with low, even slopes, and are designed to accept runoff as overland sheet flow *only*. Formerly common agricultural practices, VFS have now become common practice for treating runoff from roads, highways, and other pervious surfaces.

A photograph of a vegetated buffer strip is shown in Figure 4-7. The dense vegetative cover facilitates conventional pollutant removal through sedimentation and infiltration.



Figure 4-7: Filter strip along side of highway

Filter strips cannot treat high velocity flows, and do not provide enough storage or infiltration to effectively reduce peak discharges to predevelopment levels for design storms. This lack of quantity control restricts their use to relatively small tributary areas.

VFS are applicable in many different areas; however, there are two primary applications for vegetative filter strips. Roadways and small parking lots are ideal locations where runoff that would otherwise discharge directly to a receiving waterbody, passes through

the filter strip before entering a conveyance system. Properly designed roadway medians and shoulders make effective vegetated filter strips. The second application is land maintained in the natural condition adjacent to perimeter lots in subdivisions that will not drain via gravity to other stormwater treatment systems. The catchment area must have sheet flow to the filter strips without the use of a level spreader. VFS often require a large amount of space relative to other BMPs so they can be restricted in some areas beyond those two examples mentioned above.

Successful performance of filter strips relies heavily on maintaining shallow dispersed flow. If runoff is flowing over the VFS too fast, or in a concentrated manner, it will likely lead to rill erosion or scouring. To avoid flow channelization and maintain performance, a filter strip should:

- Contain dense vegetation with a mix of erosion resistant, soil binding species;
- Engineered vegetated filter strips should be graded to a uniform, even and a slope of less than 20% (5:1);
- Natural vegetated filter strip slopes should not exceed 10% (10:1) on average, providing that there are no flow concentrating areas on the strip; and
- Laterally traverse the contributing runoff area.

Filter strips can be used upgradient from watercourses, wetlands, or other water bodies, along toes and tops of slopes, and at outlets of other stormwater management structures. The most important criteria for selection and use of this BMP are space and slope.

Selection Criteria

- Soils and moisture are adequate to grow relatively dense vegetative stands;
- Sufficient space is available;
- Slope is less than 20% (5:1); and
- Comparable performance to more expensive structural controls.

Limitations

- Can be difficult to maintain sheet flow (there is a tendency to form rills or gullies);
- Cannot be placed on steep slopes;
- Area required may make infeasible on some sites; and
- Poor soils which cannot sustain a grass cover crop.

Cost Considerations

Filter strips are one of the least expensive stormwater treatment options and cost less to construct than curb and gutter drainage systems. This is one reason why they are often used in conjunction with other storm water management practices in a treatment train approach.

4.4 Porous Pavement

Porous pavements are a special type of pavement that allows rain to pass through it. They can be used on both permeable and impermeable soils and in the latter case are designed with an underdrain system. Where soils are sufficiently permeable all the runoff will infiltrate and no discharge of stormwater or associated pollutants will occur. Systems designed with an underdrain provide substantial pollutant removal and increase the time of concentration, which are substantial benefits even when the volume of runoff is not substantially reduced.

There are several types of porous pavement, including porous asphalt, pervious concrete, pavers, and grid type systems. Porous asphalt pavement consists of an open-graded coarse aggregate, bonded together by asphalt cement, with sufficient interconnected voids to make it highly permeable to water. Pervious concrete consists of specially formulated mixtures of Portland cement, uniform, open-graded coarse aggregate, and water. Pervious concrete has enough void space to allow rapid percolation of liquids through the pavement. Pavers themselves are typically impermeable; however, infiltration occurs either in the gaps between the pavers or within openings cast as part of the geometry of the paver. The use of pavers in a portion of a parking lot is presented in Figure 4-8.



Figure 4-8: Picture of permeable pavers in portion of parking lot in San Antonio (courtesy of David Dods)

The porous pavement surface is typically placed over a highly permeable layer of open-graded gravel and crushed stone. The void spaces in the aggregate layers act as a storage reservoir for runoff. A filter fabric is placed beneath the gravel and stone layers to screen out fine soil particles. Figure 4-9 illustrates a common porous paver installation and demonstrates the use of the filter fabric between gravel and stone layers.



Figure 4-9: Porous pavement sidewalk installation with filter fabric placed beneath the gravel and stone layers (courtesy of URS Corporation).

Two common modifications made in designing porous pavement systems are:

- (1) Varying the amount of storage in the stone reservoir beneath the pavement; and

(2) Adding perforated pipes near the top of the reservoir to discharge excess storm water after the reservoir has been filled.

Some municipalities have also added stormwater reservoirs (in addition to stone reservoirs) beneath the pavement. These reservoirs should be designed to accommodate runoff from a design storm and should provide for infiltration through the underlying subsoil if an underdrain is not provided.

Selection Criteria

Porous pavement may substitute for conventional pavement on parking areas, areas with light traffic, sidewalks, and patios. Slopes should be flat or very gentle. For systems installed without underdrains, soils should have field-verified permeability rates of greater than 0.5 in/hour, and there should be a 4-foot minimum clearance from the bottom of the system to bedrock or the water table.

The advantages of using porous pavement include:

- Substantial pollutant reduction, even in systems with underdrains with surface discharge;
- Increased time of concentration;
- Less need for curbing and storm sewers; and
- Potential for groundwater recharge.

Limitations

The use of porous pavement is constrained, requiring deep permeable soils (in systems without underdrains), low traffic loads, and consideration of impacts to adjacent buildings. Some specific disadvantages of porous pavement include the following:

- Many pavement engineers and contractors lack expertise with this technology;
- Porous pavement has a tendency to become clogged if improperly installed or maintained;
- Porous pavement has a high rate of failure;
- There is some risk of contaminating groundwater, depending on soil conditions and aquifer susceptibility; and
- Fuel may leak from vehicles and toxic chemicals may leach from asphalt and/or binder surface. Porous pavement systems are not designed to treat these pollutants.

Cost Considerations

Estimated costs for an average annual maintenance program of a porous pavement parking lot are approximately \$200 per acre per year. This cost assumes four inspections each year with appropriate jet hosing and vacuum sweeping treatments.

4.5 Rainwater Harvesting

Rainwater harvesting - collecting rainwater from impervious surfaces and storing it for later use - is a technique used for millennia. In drought stricken Central Texas and other areas around the country with limited water resources and stormwater pollution, the role that rainwater harvesting can play for water supply is being reassessed for both residential and commercial buildings. Thus, it is important to note that there are current changes being made to local rainwater harvesting law, and design criteria are often modified, so it is best to check the most current regulations and incentives before implementing this practice.

Rainwater can be stored in a variety of structures. These include small 55 gallon barrels, the most common sizes for residential applications, to large underground cisterns. A picture of a rainwater collection system with a large above ground storage tank is provided in Figure 4-10. Further, cisterns and barrels can be constructed of many different materials including wood, metal, plastic, glass, or synthetic compounds.



Figure 4-10: Picture of a rainwater collection system (courtesy of David Dods)

While potable use is possible for harvested rainwater, necessary on-site treatment and perceived public health concerns will likely limit the quantity of rainwater used for potable demands. Irrigation and the non-potable uses of toilets, urinals and HVAC make-up are currently the most common end uses for harvested rainwater. These are all beneficial uses as individually, and even combined, they constitute a significant portion of residential and commercial water demand.

Focusing harvested rainwater on irrigation and selected non-potable indoor uses can significantly lower demand while allowing a balance and public comfort level between municipal potable water and reused rainwater. For harvesting systems to be efficient stormwater retention systems, the collected rainwater needs to be used in a timely manner to ensure maximum storage capacity for subsequent rain events. Cistern systems generally supply uses with significant demands to ensure timely usage of the collected water.

Outreach and education is a critical component of rain barrel programs, however, because of the more episodic and less structured use of this collected water. Municipalities should inform homeowners of the steps needed to maximize the effectiveness of their rain barrels.

Selection Criteria

- Contributes to water conservation;
- Augments drinking water supplies;
- Reduces stormwater runoff and pollution;
- Reduces erosion in urban environments; and
- Provides water that needs little treatment for irrigation or non-potable indoor uses.

Limitations

- Very few states and local jurisdictions have developed standards or guidelines for rainwater harvesting, especially its use indoors;
- Sufficient storage needs to be available to capture subsequent rain events, so the stored water needs to be used relatively rapidly; and
- It is difficult for regulators to ensure that these small, dispersed systems are being operated in a way to significantly reduce stormwater runoff.

Cost Considerations

The average cost of water delivered by municipal distribution systems is very low, which generally puts rainwater harvesting at a disadvantage compared to potable water when only the economics of water supply are considered. However, when these systems are sufficiently large, they may reduce the size of downstream detention facilities. In areas

without water distribution systems and poor groundwater quality, rainwater harvesting may provide the best option for providing high quality water for indoor use.

This manual does not provide design guidance for rainwater harvesting as there are a variety of design options available. Further design guidance can be found in the following resources:

- Texas Water Development Board:
<http://www.twdb.state.tx.us/innovativewater/rainwater/>
http://www.twdb.state.tx.us/publications/reports/RainwaterHarvestingManual_3rdedition.pdf
- Brad Lancaster. *Rainwater Harvesting for Drylands and Beyond*.
- Texas A&M University Rainwater Harvesting Calculator:
<http://rainwaterharvesting.tamu.edu/2011/05/31/calculator/>

4.6 Treatment Trains

A treatment train consists of a series of stormwater practices installed in series. There are a number of reasons that this type of configuration is preferred. First, implementing a number of practices provides the opportunity to include a variety of unit processes (sedimentation, filtration, biological uptake, etc.) to treat the runoff, which optimizes the pollutant removal. Secondly, the use of multiple systems provides a level of redundancy so that at least partial treatment is being achieved even if one system is not functioning properly.

Probably the biggest benefit is the reduction in maintenance costs that can be achieved by using a dry system, such as a swale, upstream of ponds or other permanently wet facilities. Removal of accumulated sediment, trash, and debris from a dry swale is far easier and less expensive than removal of the same material once it enters a pond.

The configuration for a treatment train can take many different forms. Common applications include the use of a vegetated swale to convey stormwater to or from other treatment systems, such as bioretention cells. Swales can provide some level of pretreatment when installed upstream of other facilities and can provide the opportunity for some ancillary infiltration even when that is not the primary goal of implementing this practice. Other applications include the treatment train system described in Section 0 where disconnected downspouts are directed through a series of additional BMPs. If there is excess runoff at the end of a treatment train system, the treated stormwater could then be connected to the storm sewer or other area. Figure 3-4 provided an example of a treatment train installation.

4.7 Additional LID BMPs

Thus far, Chapter 4 has described five structural LID practices that can be used to convey, treat, and infiltrate stormwater runoff in San Antonio. Though the LID toolbox is unlimited, this manual focuses on the above structural tools as they are most appropriate for the San Antonio region. This last section discusses several other structural controls in brief, including a description of the technique and some important design considerations and limitations to each practice.

4.7.1 Green Roofs

Green roofs, also known as vegetated- or eco-roofs, are roofs with a vegetated surface and growing media substrate. Green roofs are typically grouped into two distinct categories: extensive and intensive. Extensive green roofs have a shallower soil media, typically 6” or less, and thus support mainly low-growing ground cover. Intensive green roofs have a deeper amount of substrate (6” or more) and can include a variety of uses and vegetation, including trees. These intensive green roofs also have the appearance of a ground level garden, and thus can require additional investments in plant maintenance. Whether intensive or extensive in design, all green roofs contain, in their simplest design, an insulation layer, a waterproof membrane, a root barrier, a layer of growing medium and vegetation.

Benefits

Research has shown that green roofs can, if adequately designed, exhibit many benefits, and that these benefits are even more substantial in urban areas such as noise reduction, heating / cooling benefits, improved water quality, habitat provision, and runoff volume reductions. With regard to stormwater management, green roofs can prevent or reduce runoff from the lot by capturing it on the rooftop via plants, growing media and other green roof structural features (Oberndorfer et al., 2007). Rainfall soaks into the green roof’s media layer, detaining runoff until after peak rainfall, and plants help return this moisture to the atmosphere through evapotranspiration. Of course, depth of media, plant type and regional climatic factors including rainfall patterns all directly affect the amount of runoff delay and reduction. However, studies have consistently shown that there is potential benefit in terms of stormwater management when compared with a conventional roof.

Limitations

There are several limitations to green roof implementation and most of these limitations depend on the system’s design, including each of the components. First, green roofs are

expensive LID tools, because their implementation can require specific media mixes or structural modifications to support the added weight on retrofit projects, and liability concerns among other items. Second, although there has been demonstrated sequestration of potential water pollutants such as nitrates and heavy metals, some research has demonstrated that runoff from green roofs can include increased levels of organic carbon, nitrogen and phosphorus due to leaching from the substrate, particularly if the green roof substrate includes high-nutrient organic matter or fertilizers. Additional research is needed to investigate growing mediums which do not contribute pollutants to runoff. Part of this needed research is to examine regionally appropriate plants that might optimize the uptake of nutrients or contaminants or conversely, not require any fertilizer or high-nutrient compost. Third, in the certain Texas regions, with its extended periods of intense heat and drought, it can be difficult to keep green roof vegetation alive without regular irrigation. It is important to choose regionally-appropriate plant species that can withstand drought and high air and soil temperatures found in this sub-tropical region. It is important to note that many appropriate green roof species may go dormant during the summer months and that aesthetic does not always match the desired goals of the project. Lastly, it is essential to specify the performance objectives of the roof upfront to optimize success and efficacy of the green roof system. Specifying performance goals helps to ensure that the manufacturer supplied system suits the design needs and is not simply an unspecified green roof for its own sake.

4.7.2 Proprietary Systems

Currently, there are many proprietary systems on the market designed to meet stormwater management goals. Suppliers of these systems all have specific design and maintenance criteria available if this a desired option for a project site.

Benefits

There are many benefits to these and other systems currently on the market. First, many of these systems, like the other structural systems described above, can be custom designed for a specific project with regard to media mix and vegetation. Secondly, they can be a good choice for highly urban areas where space is limited or where retrofits to existing storm drain are desired. Lastly, they can be efficient to implement and often offer guarantees against performance and structural failure.

Limitations

While proprietary systems have certain advantages, they also have several limitations. First, under current regulations, several proprietary systems are not allowed in certain jurisdictions or over aquifer recharge or contributing zones.⁸ Thus, it is important to investigate any local or regional regulatory obstacles that may exist which prohibit or prescribe their application. Second, these systems can be limited in their ability to address site performance goals and the regional ecological conditions to the fullest degree. Many of the proprietary systems are designed to reach certain performance targets, such volume reductions or solely filtration purposes, or a combination. If this approach is chosen, it is important to understand the various performance goals for each system to understand if these match the performance goals of a project.

4.7.3 Constructed Wetland & Wet Ponds

A constructed wetland is a constructed basin that has a permanent pool of water throughout the year (or at least throughout the wet season) and differs from wet ponds primarily in being shallower and having greater vegetation coverage. Constructed wetlands are now used to remove point and nonpoint water pollutants from stormwater runoff as well as from domestic wastewater, agricultural wastewater, landfill leachates, and coal mine drainage among other industries. For some wastewaters, constructed wetlands are the sole treatment; for others, they are one component in a sequence of treatment processes. Constructed wetlands can be highly effective systems; however, to be effective, they must be carefully designed, constructed, operated, and maintained. A distinction should be made between using a constructed wetland for storm water management and diverting storm water into a natural wetland. The latter practice is not recommended and in all circumstances, natural wetlands should be protected from the adverse effects of development, including impacts from increased storm water runoff. This is especially important because natural wetlands provide storm water and flood control benefits on a regional scale.

Wet ponds, also called stormwater ponds, retention ponds, wet extended detention ponds, differ from constructed wetlands primarily in having a greater average depth. Wet ponds treat incoming stormwater runoff by settling and biological uptake. The primary removal mechanism is settling as stormwater runoff resides in this pool, but pollutant uptake, particularly of nutrients, also occurs to some degree through biological activity in the pond. Wet ponds are among the most widely used stormwater practices. While there are several different versions of the wet pond design, the most common

⁸ It is recommended that projects check current regulations to see if these rules have changed.

modification is the extended detention wet pond, where storage is provided above the permanent pool in order to detain stormwater runoff and promote settling.

These two stormwater management tools may be appropriate options for certain projects or circumstances. Design criteria and specifications can be found in the City of Austin's Environmental Criteria Manual.

Benefits

- Effective pollutant removal
- High aesthetic value
- Habitat
- Recreational / Amenity value if integrated into park setting (wet ponds)

As mentioned in Chapter 2, wet ponds and constructed wetlands are two BMPs capable of achieving high TSS removal efficiencies.

Limitations

One reason these two BMPs are not included in this manual is because these systems are end-of-pipe stormwater management treatment systems and LID practices focus on on-site, distributed, at the source controls. Additionally, some issues may arise with maintaining a certain level of water within constructed wetlands and wet ponds during drought periods which can be costly to maintain or render the BMPs ineffective if the level is reduced.

5 Design Guidelines for Structural LID Practices

In order for LID practices to perform effectively basic guidelines need to be followed in their design, construction, and maintenance. The following sections are written to guide professionals through the design process. Detailed requirements are provided for the full suite of LID practices appropriate for the San Antonio area.

The first step in the design process is to determine the volume of the annual runoff to be managed. This may be specified in existing local regulations. Or, it is possible to analyze historical rainfall data in the region to determine the relationship between the water quality volume and the amount of the annual runoff to be treated. For example, the graph below shows how in the Central Texas region, by capturing the runoff from a 1” rainfall event it is possible to treat nearly 80% of the annual runoff volume.

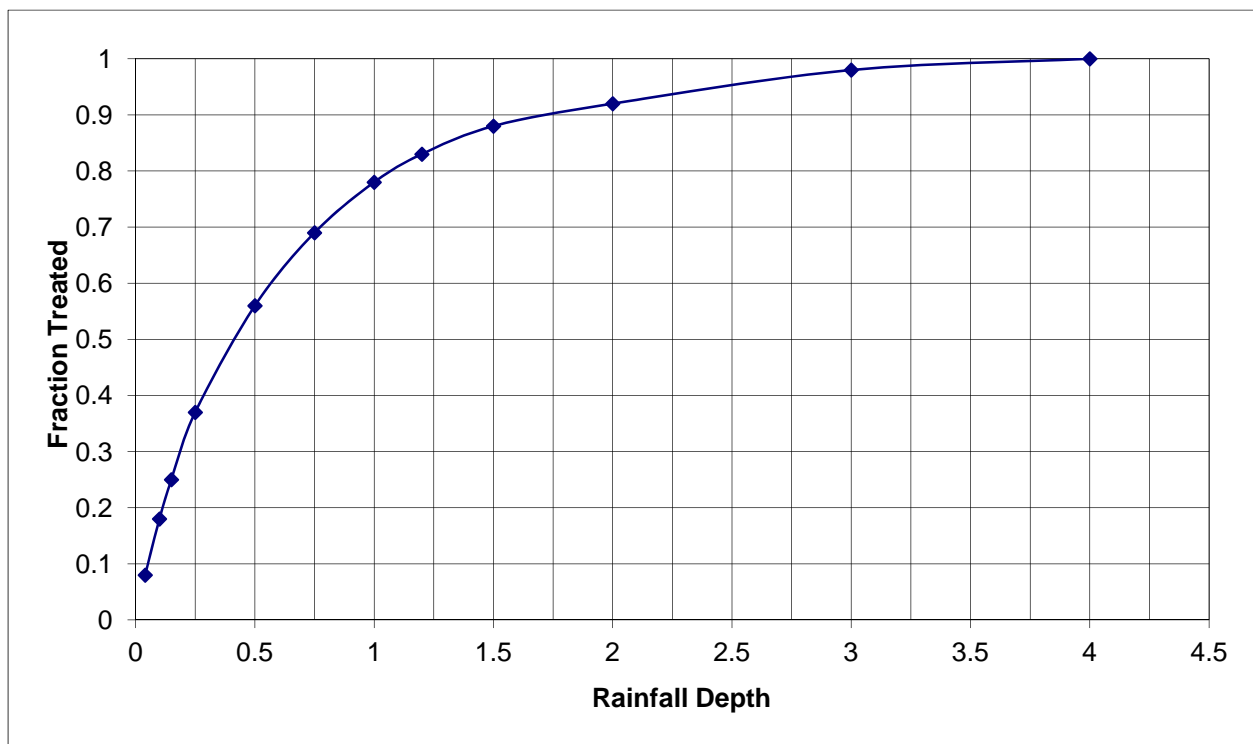

Figure 5-1: Historical rainfall pattern in the Central Texas region and resulting runoff volumes treated.

It is important to determine the water quality volume, the storage needed to capture and treat the runoff, based on local conditions, the sensitivity of the receiving body, and the desired performance goals of the BMP.

5.1 Rain Gardens & Bioretention

Rain gardens and bioretention systems are very similar BMPs in their design and function. Both systems can be used in any land use type or for any site. For the purposes of this manual, the main difference between the two systems is that a bioretention system uses engineered soils. Rain gardens do not include engineered soils, though they can include slightly modified soils. Both systems can be designed with or without underdrains or liners.

One advantage to rain gardens is that these are slightly simpler systems that can be easily implemented without the need for special training. Though they can be implemented and useful in many applications, they are also a good BMP for homeowners to implement on their own property. These features are easily integrated into site landscaping and their design can be formal or informal in character.

5.1.1 Rain Gardens

Rain gardens provide both sedimentation and filtration of stormwater, and infiltration when no underdrain is used. While sedimentation and filtration will occur throughout the entire surface area of the rain garden, the majority of sedimentation occurs in the immediate area of runoff entry. The entry area should be accessible if possible for occasional sediment removal. River stones and/or rip rap along with native groundcovers should be present throughout the entry area to diffuse water velocity and reduce erosion or scouring (especially if runoff enters through a single point of entry rather than from sheet flow). In addition, taller grasses can be planted around the edge of the entry area to help collect large floatables or other debris which might enter the system. Or in certain circumstances, curb inlets can contain sediment and debris collection devices as discussed in Section 5.1.2 and demonstrated in Figure 5-7 below. The rain garden should be planted with, where appropriate, trees and a mixture of grasses and perennial species. Further detail on plant selection is provided in Section 5.1.3.

Figure 5-2 below shows an example of a rain garden design following (2009) City of Austin guidelines. The rain garden receives runoff from the street and enters the sedimentation area before entering the filtration portion. As shown, the sedimentation area, defined as 20% of the rain garden, is separated from the filtration zone, defined as 80% of the rain garden, with a perimeter of densely planted tall grass species.

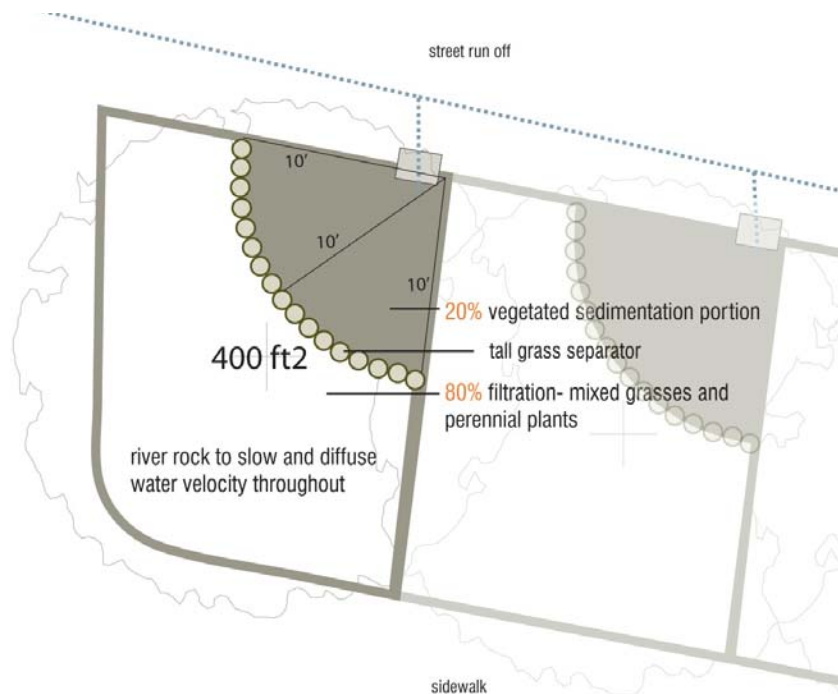

Figure 5-2: An example of a rain garden design following City of Austin specifications as described in Section 1.6.7 of the Environmental Criteria Manual (2009).

Rain gardens should be designed to draw down (i.e., empty any ponded water) within 48 hours and to overflow only during larger storm events. Side slopes will vary depending on site constraints and should be designed appropriately for space, soil, and velocity of influent. To properly size a rain garden, the following elements need to be considered: the amount of runoff routed to the garden, the designed water quality volume, the ponding depth, the side slopes, and the infiltration rate.

1) Rain gardens may have mulch topdressing to help reduce erosion and provide preliminary pollutant removal capabilities in addition to the horticultural benefits. Recommended mulch layer can be anywhere from 1-3". Conventional mulch material includes shredded bark, but additional options provide similar function such as rock, pecan shells or other locally sourced material. Mulch topdressing is optional and should be carefully considered as softer materials (e.g., wood) can either float or be pushed out of the system during larger rainfall events. A hybrid mulching approach might include using rock on the bottom of the garden and a secondary material on the higher side slopes.

2) In a rain garden, the media should be 18" at minimum.

3) The rain garden media may be composed of either native soil where infiltration rates are sufficient or amended native soils where existing soils have low infiltration rates. Soil amendments are described in Section 5.2.2 below.

4) The entry point to a rain garden, whether via curb cut or other method, can contain several design modifications to act as catchment areas for trash or large amounts of debris as shown in Figure 5-7 below. Further, when siting bioretention facilities to intercept drainage, the designer should attempt to use the preferred "off-line" facility design. Off-line facilities are defined by the flow path through the facility. Any facility that utilizes the same entrance and exit flow path upon reaching pooling capacity is considered an off-line facility. (See #2 of Section 5.1.2 below.)

5) The area below the native or amended native soil media should be undisturbed, non-compacted native soils. To avoid compaction of native soils beneath the rain garden, do not put any heavy equipment or machinery in the rain garden. If using heavy equipment to construct the rain garden, keep the machinery outside of the area. Soils can be protected in a designated vegetation and soil protection zone (VSPZ). If compaction does occur, soil should be restored to bulk density prior to construction (if using this approach, bulk density analysis should take place before any activity) or improved according to the designed infiltration rate. One common method to restore soils post-compaction is to rip or roughen the soils.

6) Rain gardens should have 6" of ponding depth. The ponding depth can be greater in higher permeability soils if the facility is designed to infiltrate within 48 hours.

7) Underdrains are recommended if the system is installed in soils with infiltration rates of less than 0.5 in/hr. Some designers are replacing the geotextile fabric between the planting media and gravel layer with a bridging layer of pea gravel, since clogging of the textile has occasionally been shown to be a cause of failure. This option is also acceptable.

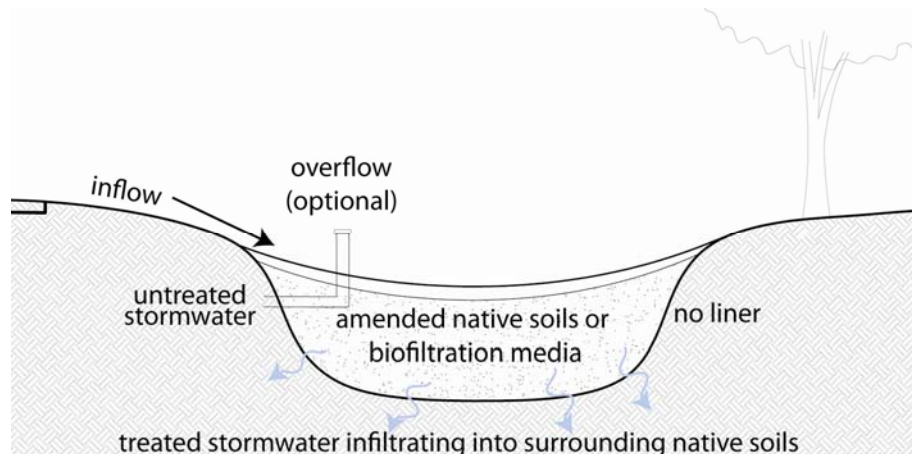

Figure 5-3: Rain garden schematic with no underdrain.

5.1.2 Bioretention

Bioretention facilities are effectively sand filters that include additional organic and soil material in the filtration media to support vegetation. This allows these facilities to be integrated into the site landscaping where they can provide unobtrusive treatment of stormwater runoff.

The design configuration of bioretention is similar to that of the rain garden described above, and somewhat flexible. Bioretention provides both sedimentation and filtration of stormwater, and infiltration when no underdrain is used. While sedimentation and filtration will occur throughout the entire surface area of the bioretention system, the majority of sedimentation occurs in the immediate area of runoff entry. Possible design variations of bioretention systems include removal of the underdrain (to promote infiltration into the surrounding soil) or the inclusion of a permanently wet, anoxic zone at the bottom (to further enhance nitrogen removal), or a combination. Figure 5-4 illustrates bioretention in an urban setting with a combination of curb design and infiltration/filtration systems.

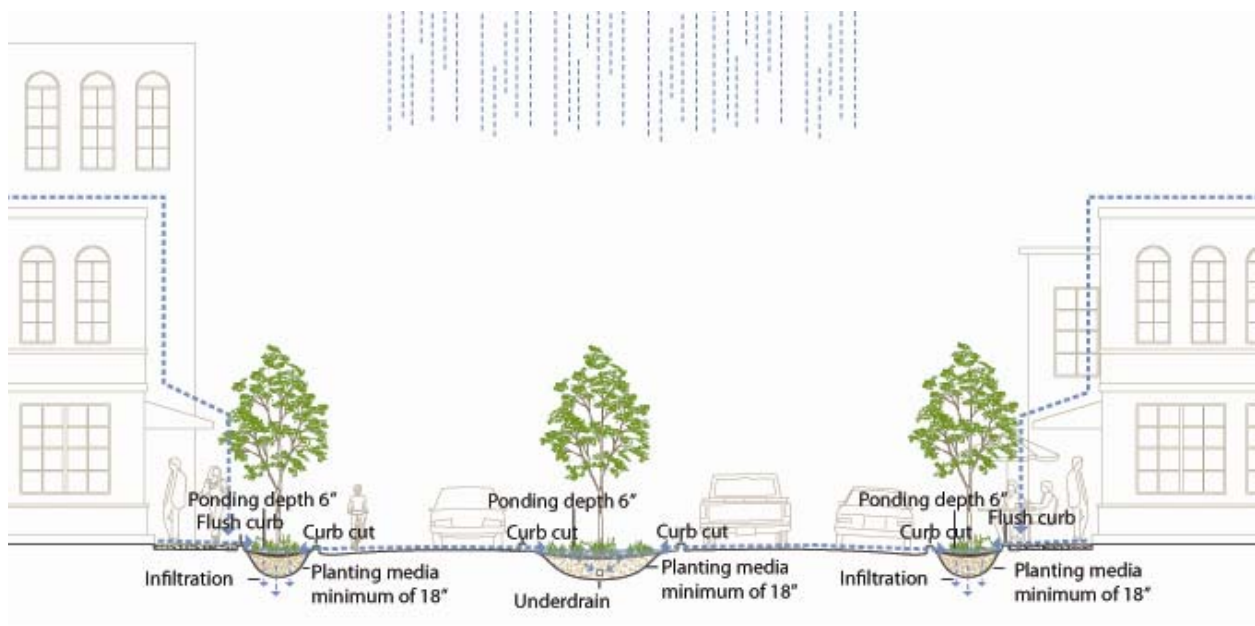

Figure 5-4: Bioretention along streets with a combination of infiltration and underdrain.

The reader should also be aware that there are proprietary versions of bioretention systems commonly called “tree box filters”, which will provide a comparable level of pollutant removal. Design of these systems should follow manufacturer’s recommendations.

Figure 5-5 details the various required and optional design components of a bioretention system. The figure includes a grass filter strip for pretreatment of the runoff to reduce sediment loading to the bioretention cell. This is a useful component, but is not required and may not be feasible depending on space constraints at the site. The “gravel curtain drain” and “optional sand filter layer” are not common or required.

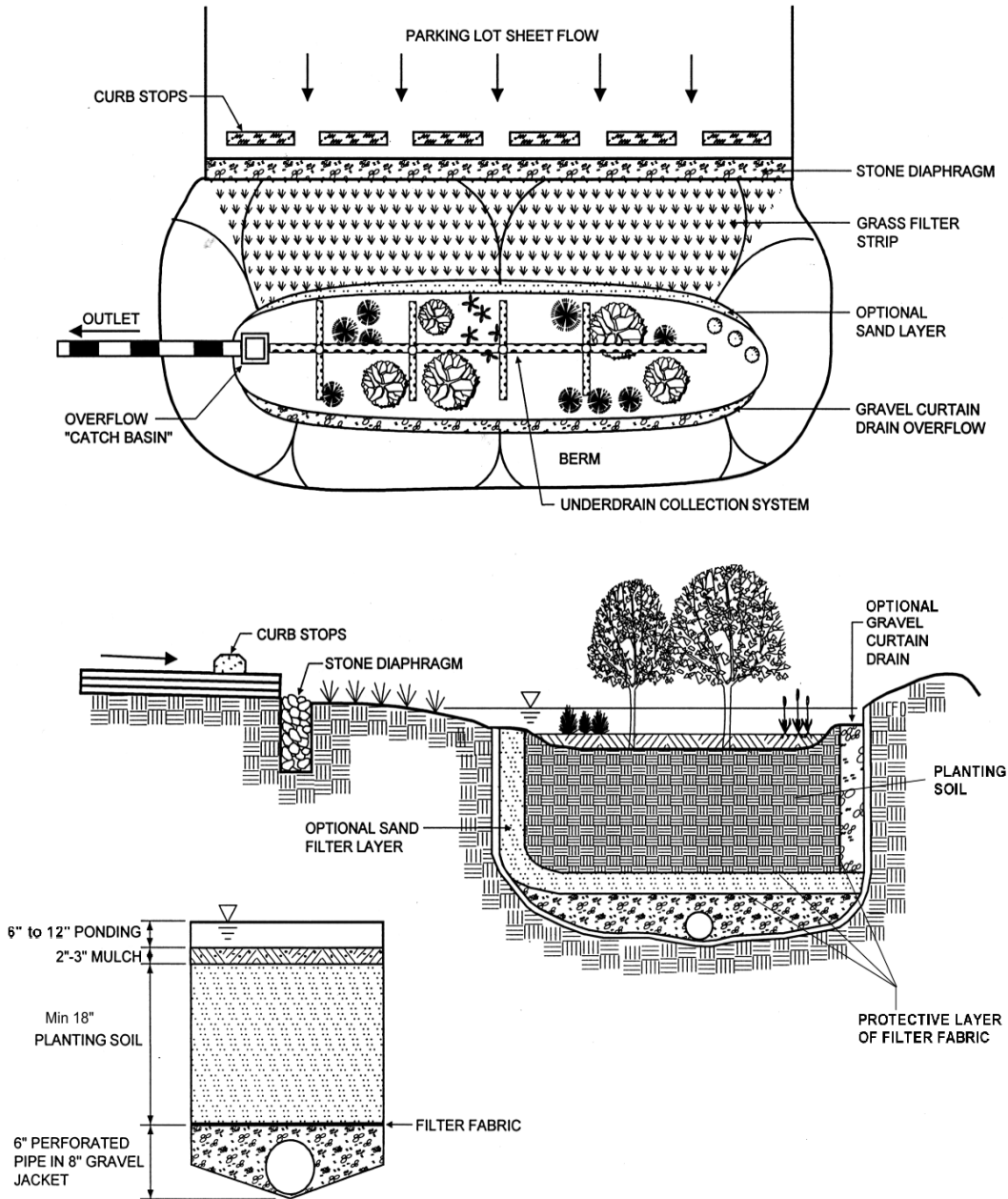

Figure 5-5: Schematic diagram of a bioretention system.

The following design guidelines are appropriate for conventional systems in the public domain.

- 1) *Water Quality Volume* – The water quality volume of the facility should be calculated according to any existing local regulations or to the description provided in Section 5.1.
- 2) *Inlet Design* - When siting bioretention facilities to intercept drainage, the designer should attempt to use the preferred "off-line" facility design. Off-line facilities are defined by the flow path through the facility. Any facility that utilizes the same entrance and exit flow path upon reaching pooling capacity is considered an off-line facility.
- 3) *Curb Cut Inlet* – There are several design options for curb cuts, where curbs are used or modified, to allow runoff to enter the bioretention or rain garden system. Several of these (non-exclusive) options are diagrammed below. The last option in the figure below demonstrates one type of inlet where a sediment / debris catchment area is included. These types of modifications can provide places to catch larger items such as soda cans or other floatables and can be designed with grates where water flows through the 'box' and into the rain garden or be designed to be level with the base of the bioretention system. In either method, they should be designed to be shovel-size for easy maintenance.

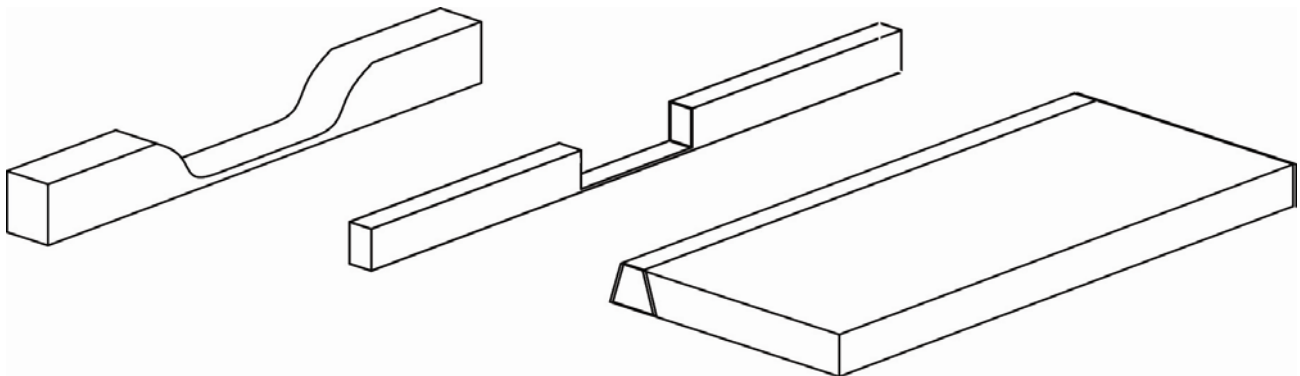

Figure 5-6: Curb cut options: smooth cut, hard cut and flush curb

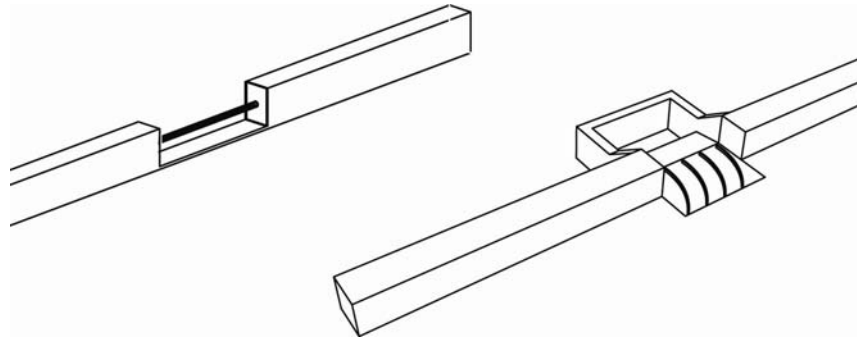

Figure 5-7: Curb cuts with optional sediment / trash screens

- 4) *Filtration Area* – The footprint of the media should be sufficiently large that it underlies the entire flooded area for the design water quality volume. A common requirement for the water depth over the media for the design storm is recommended not to exceed 6 inches unless pretreatment with a 6 foot wide grass filter strip is provided. In that case, water depths as great as 12 inches are allowed. Even without a pretreatment area, the allowable water depth over the media could be greater with higher permeability soils if the facility is designed to infiltrate within 48 hours.
- 5) *Media Properties* – The filtration media should have a minimum thickness of 18 inches. If planting trees in bioretention system, additional media may be needed, up to 30”, but is not required. The media should have a maximum clay content of less than 5%. The soil mixture should be 75-90% sand; 0-4% organic matter; and 10-25% screened bulk topsoil. The soil should be a uniform mix, free of stones, stumps, roots, or other similar objects larger than two inches. No other materials or substances should be mixed or dumped within the bioretention that may be harmful to plant growth, or prove a hindrance to the planting or maintenance operations. Provide clean sand, free of deleterious materials. Sand may be composed of either ASTM C-33 (concrete sand) or ASTM C-144 (masonry sand).

Several additional media design options exist to use other materials aside from sand as the filtration component. These include crushed limestone, crushed (and recycled) glass, or manufactured sand. These additional options are acceptable to use as they function similar to sand and provide a more sustainable media as they are locally sourced, often recycled, materials that are not mined. However, if using one of these media types such as crushed glass, it is important to include a small amount of organic matter for the vegetation.

The organic matter listed above should be carefully selected. Traditional options for organic matter include peat moss or shredded bark mulch. Additional options include rice hulls or shredded paper. Compost can be an acceptable organic matter in bioretention systems but it must be used with caution. There have been some issues with using compost and resulting water quality leaving the system. However, this is often due to compost that is high in nutrients or immature compost. Only low-nutrient compost should be used, and preferable compost that is very mature (processed for at least 6 months).

- 6) *Underdrains* – Underdrains are recommended where infiltration rates are lower than 0.5 in/hr. While there is some flexibility here, the idea is to make sure the system does not remain saturated for an extended period of time. The underdrain piping should consist of a main collector pipe and two or more lateral branch pipes, each with a minimum diameter of 4 inches. Underdrains should be perforated with $\frac{1}{4}$ - $\frac{1}{2}$ inch openings, 6 inches center to center. The pipes should have a minimum slope of 1% (1/8 inch per foot) and the laterals should be spaced at intervals of no more than 10 feet. Each individual underdrain pipe should have a cleanout access location. Ideally the cleanout access will be located in the facility embankment to reduce the possibility of bypass if the cleanout is damaged (see Figure 5-8 for example). All piping is to be Schedule 40 PVC.

A configuration like that shown in Figure 5-8 is preferred. In this configuration, the underdrain is installed above the invert of the excavation to promote infiltration. The filter fabric does not need to extend to the side walls. The filter fabric may be installed horizontally above the gravel blanket- extending just 1-2 feet on either side of the underdrain pipe below. Do **not** wrap the underdrain with filter fabric. Some designers are replacing the geotextile fabric between the planting media and gravel layer with a bridging layer of pea gravel, since clogging of the textile has occasionally been shown to be a cause of failure. This option is also acceptable.

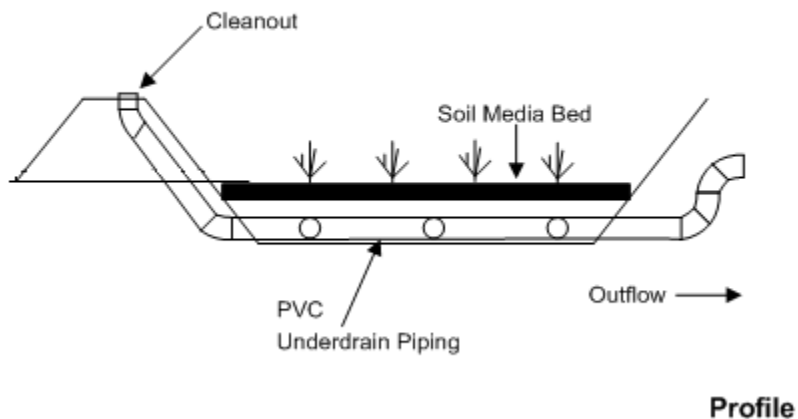

Figure 5-8: Detail of cleanout location

- 7) *Liners* – Liners must be used in facilities in areas with the potential for groundwater contamination. Liners are required over the Edwards Aquifer recharge zone to prevent groundwater contamination. For liner specifications and design details, please see the document *Complying with the Edwards Aquifer Rules: Technical Guidance on Best Management Practices*⁹. In the contributing and transition zones, liners are not required and this will allow some portion of the runoff to infiltrate.

Impermeable liners may be clay, concrete or geomembrane. Use of any of these three liners must meet local specifications. If none exist, guidance can be found in the City of Austin’s *Environmental Criteria Manual*¹⁰ or the document *Complying with the Edwards Aquifer Rules: Technical Guidance on Best Management Practices*. Installation methods for liners will vary according to site requirements.

- 8) *Outlet* – A raised outlet as illustrated in Figure 5-9 is optional. It has the potential advantage of reducing the headloss across the facility and providing a permanent pool that will provide additional water for the plants during long dry periods.

⁹ http://www.tceq.texas.gov/publications/rg/rg-348/rg-348.html/at_download/file

¹⁰ Please note that as of time of writing, the City of Austin was revising their Environmental Criteria Manual. The most current liner specifications should be used when designing bioretention systems with liners and it is recommended that for the Pflugerville area, any newly released specifications in Austin should trump the specifications listed in #7 above.

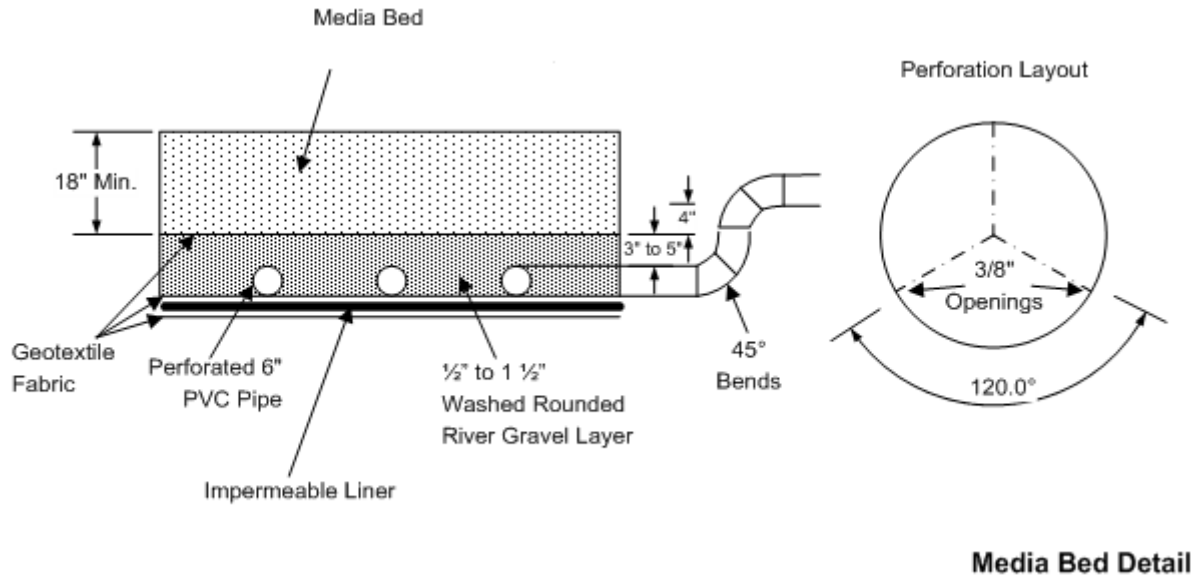

Figure 5-9: Illustration of optional outlet design

- 9) *Setbacks* - When siting bioretention facilities, a 50 foot setback from septic fields should be provided. Setback from a foundation or slab should be 5 feet or greater.
- 10) *Vegetation* – Vegetation selected for the bioretention system should be both tolerant of frequent inundation during extended periods of wet weather and drought tolerant for extended dry periods. Buffalograss (*bouteloua dactyloides*) and big muhly (*muhlenbergia lindheimeri*) have both been shown to provide enhanced nutrient removal. More detail on plant selection is provided in Section 5.1.3.
- 11) *Installation* - Installation of filter media must be done in a manner that will ensure adequate filtration. After scarifying the invert area of the proposed facility, place soil. Avoid over compaction by allowing time for natural compaction and settlement. No additional manual compaction of soil is necessary. Rake soil material as needed to level out. For facilities designed with a liner, no scarification of the invert area is required.

Recommended Maintenance

The primary maintenance requirement for bioretention areas is that of inspection and repair or replacement of the treatment system's components. Generally, this involves nothing more than the routine periodic maintenance that is required of any landscaped area. New Jersey's Department of Environmental Protection states in their bioretention systems standards that accumulated sediment and debris removal (especially at the inflow point) will normally be the primary maintenance function. Other potential tasks include replacement of dead vegetation, soil pH regulation, erosion repair at inflow points, mulch replenishment, unclogging the underdrain, and repairing overflow structures.

Recommended maintenance guidelines include:

- *Inspections.* BMP facilities should be inspected at least twice a year (once during or immediately following wet weather) to evaluate facility operation. During each inspection, erosion areas inside and downstream of the BMP must be identified and repaired or revegetated immediately. More frequent inspections of the vegetative cover during the first few years after establishment will help to determine if any problems are developing, and to plan for long-term restorative maintenance needs. Additional inspection after periods of heavy runoff is most desirable. The facility should be checked for uniformity of vegetative cover, debris and litter, and areas of sediment accumulation.
- *Sediment Removal.* Remove sediment from the facility when accumulated sediment hinders the flow of water into the facility.
- *Drain Time.* When the drain time exceeds 48 hours, any filter media that has been clogged by sediment should be removed. The penetration of sediment may vary in depth across the facility and will typically be heaviest where inflowing storm water loses velocity. Any removed filter media should be replaced with material that meets the specifications contained in the design guidance.
- *Pest Management.* An Integrated Pest Management (IPM) Plan should be developed for vegetated areas and should specify how problem insects and weeds will be controlled with minimal or no use of insecticides and herbicides.
- *Debris and Litter Removal.* Debris and litter will accumulate in the facility and should be removed during regular mowing operations and inspections.
- *Filter Underdrain.* Clean underdrain piping network to remove any sediment buildup as needed to maintain design drawdown time.
- *Vegetation.* See below.

Most of the maintenance routines for bioretention and rain garden systems revolve around vegetation and media health and function. The first step towards a low-maintenance system is proper plant selection, described in more detail below in Section 5.1.3. Plants appropriate for the site, climatic, and watering conditions should be selected for use in the bioretention system. Appropriately selected plants will aid in reducing irrigation needs and overall maintenance requirements. Further, bioretention system components should blend over time through plant and root growth, organic decomposition, and the development of a natural soil horizon. These biologic and physical processes over time will lengthen the facility's life span and reduce the need for extensive maintenance. One way these processes can extend the life span of the system is by a healthy root structure which helps to maintain, and increase as roots continue to grow, the infiltration properties of the system.

Routine vegetation maintenance should include:

- Frequent inspections during the first 1-2 years of establishment;
- A semi-annual health evaluation of the trees and shrubs and subsequent removal of any dead or diseased vegetation once established. Diseased vegetation should be treated as needed using preventative and low-toxic measures to the extent possible. Any species to be removed shall be replaced during semi-annual inspections;
- Inspection of media/soil health and compaction over time;
- Routine inspections for areas of standing water within the BMP and corrective measures to restore proper infiltration rates are necessary to prevent creating mosquito and other vector habitat;
- Routine inspections for invasion by aggressive, undesirable, plant species;
- In order to maintain the treatment area's appearance it may be necessary to prune and weed; and
- When used, mulch replacement is suggested when erosion is evident or when the site begins to look unattractive. Spot mulching may be sufficient when there are random void areas; in this case, re-mulch any bare areas by hand whenever needed in landscaped areas of the basin. The entire area may require mulch replacement every two to three years, in the spring, or more or less frequently depending on the system's design and use. For example, if a system is situated in an area where the facility does not receive a high amount of runoff, mulch replacement may only be needed every few years (as it will decompose faster in wetter conditions). The rate of decomposition of the mulch will also depend on its source. If the mulch has degraded evenly over a year or several year period, mulch addition (rather than replacement) is also an option.

5.1.3 Plant Selection & Considerations

Plant selection shall be made based on the desired function of the area, the expected inundation period, rain patterns, amount of water that is being captured, media type and infiltration rates, and the desired aesthetic qualities of the BMP. Plants should be selected as dry, drought tolerant species that can handle long periods of inundation. Plants should **not** be wetland species. In many areas of Texas, many dry creek bed species fit this type of requirement.

Plants should be selected which:

- Are adapted to rain garden hydrology (i.e. periodic flooding and drought);
- Are adapted to the soil type;
- Are suitable for their specific function (e.g. erosion control, filtration, etc.);
- Are durable, resilient and resistant to pests and disease;
- Are tolerant of the expected pollutant load in stormwater runoff ;
- Have a root system of the desired type, mass and depth;
- Are resistant to weed invasion;
- Require minimal maintenance; and
- Are not invasive.

Planting Considerations:

(1) *Plant Density*: Vegetated cover with herbaceous material should be at least 70% coverage within the biofiltration area once established. If the project desires a more immediate finished aesthetic it might be best to plant more densely and then remove plants as needed. Research has indicated that as the plant density increases so does the functioning of the system. At the establishment phase, at least 50% of the system's area should be planted. While this planting density may seem high, it takes into consideration many factors for successful establishment and longevity of the system. Lastly, the denser the planting strategy, the less mulch will be required.

(2) *Soil Modifications*: It is important to consider soil modifications when choosing plant species for various LID BMPs. For instance, plants that survive well in clay soils will not be appropriate for a modified sandy media.

(3) *Biological activity*: It is important to plant a mix of cold and warm season plants so the bioretention system maintains biological activity year-round.

(4) *Installation*: Soils should be used in a manner that will ensure adequate filtration. Thus, it is important to scarify the sides and invert areas of the excavated biofiltration feature (not required for biofiltration features that require liners). Place soil in eight to twelve inch (8" – 12") lifts in order to reduce the possibility of excessive settlement. Lifts are not to be compacted, but may be slightly watered to encourage natural compaction. Rake soil to level condition. Overfill above the proposed surface grade to accommodate natural settlement (TCEQ-EAR).

(5) *Accessibility*: Bioretention areas should be designed to allow for access and aid in the maneuverability of maintenance equipment. If areas of the bioretention system are designed to be mowed, acute angles should be avoided in turf areas; wide angles, gentle, sweeping curves, and straight lines are easier to mow.

(6) *Grasses*: Prairie grasses have a high biomass and a deep rooted system that can penetrate into the clay soils and increase water infiltration. Additionally, the plants help reduce drawn-down time by drawing the water up allowing for more water storage capacity in the soil before the next rain event.

(7) *Trees*: When using trees in bioretention, consideration should be given to placement in the right-of-way or other areas where existing utilities may exist, both underground and overhead.

(8) *Procuring plants*: Bioretention areas can be seeded or planted with container plants based on the timing of the project and other site constraints.

(9) *Establishment*: Whether seeded or planted with container plants, vegetation should be allowed ample time to establish before the system is active. One option is to protect the inlet from receiving any runoff until plants are well established in the system to avoid plant death, complete submergence of plants in high rainfall events, or lack of sufficient plant cover during these early storms. The inlet can be protected with the use of sand bags.

(10) *Irrigation*: Supplemental irrigation is typically needed during the first growing season; two growing seasons for trees.

(11) *Design*: Plants species can be chosen and planted based on the zone of the bioretention system. For instance, species that can handle longer periods of inundation should be planted on the bottom while species that prefer drier conditions should be placed on the top.

(12) *Underdrain and liners*: For bioretention systems with underdrains or liners which drain water rapidly and do not allow for significant infiltration, use plants accustomed to well-drained conditions. In addition, large trees or other plants with root systems that might penetrate the liner should not be used.

(13) A few examples of recommended species of trees, grasses and forbs are listed below. Additional species with further description of all are listed in Appendix B. For more information on plant characteristics, performance, and growing conditions, please visit the following resources:

- USDA Plants Database: <http://plants.usda.gov/java/>
- Native Plant Database & Native Plant Information Network (NPIN): www.wildflower.org/explore and www.wildflower.org/plants

Grasses

A few recommended grass species for bioretention areas are listed below.

Sun:

Eastern gamagrass (*Tripsacum dactyloides*)
Seep muhly (*Muhlenbergia reverchonii*)
Bushy bluestem (*Andropogon glomeratus*)
Upland switchgrass (*Panicum virgatum*)

Shade:

Inland sea oats (*Chasmanthium latifolium*)
Indian grass (*Sorghastrum nutans*)
Cherokee sedge (*Carex cherokeensis*)

Forbs

A few recommended forb species for bioretention areas are listed below.

Sun:

Frogfruit (*Phyla nodiflora*)
Blue mistflower (*Conoclinium coelestinum*)
Baldwin's ironweed (*Vernonia baldwinii*)

Shade:

Canada germander (*Teucrium canadense*)
Horseherb (*Calyptocarpus*)

Trees

A few recommended tree species for bioretention areas are listed below. The use of trees in bioretention is valuable in terms of water infiltration and transpiration. Tree canopies intercept rainfall, reducing the amount of rain reaching the ground and lengthening the time of runoff concentration into stormwater systems. If using trees,

please consider the size of the tree at its mature stage and potential interference with any existing utilities. Trees are not recommended in bioretention systems when there is a liner covering the entire system (sides and bottom).

Sun:

Sycamore (*Platanus occidentalis*)
Bald cypress (*Taxodium distichum*)
Cedar elm (*Ulmus crassifolia*)

Shade:

Possum-haw (*Ilex decidua*)
Red mulberry (*Morus rubra*)

5.2 Vegetated Swales

A grassy swale is a sloped, vegetated channel or ditch that provides both conveyance and water quality treatment of stormwater runoff. Pollutant removal occurs through the processes of particle settling, adsorption, and biological uptake that occur when runoff flows over and through vegetated areas. There are two options available for swale design, the basic swale and the enhanced swale.

The basic swale consists of a simple vegetated channel to convey runoff to and from other LID practices. The configuration provides some level of pretreatment to reduce solids loadings to downstream practices and some runoff infiltration will also occur. TSS concentration reduction is expected to be about 70%.

An enhanced swale includes an engineered soil mixture and often an underdrain system as illustrated in Figure 5-10. At low rainfall intensities it is expected that all runoff will infiltrate through the soil media, where filtration of pollutants in runoff will occur. At high rainfall intensities, the swale will provide some level of filtration; however, the main process will revert to conveyance of runoff downstream. Design alternatives to the underdrain system exist and are acceptable as long as the system is designed to meet the filtration and conveyance properties discussed below. One example would be where several layers of highly permeable materials are present at the base of the swale, such as a large reservoir course of gravel, topped by a layer of sand, and then topped by a growing medium (with no filter fabric between the layers).

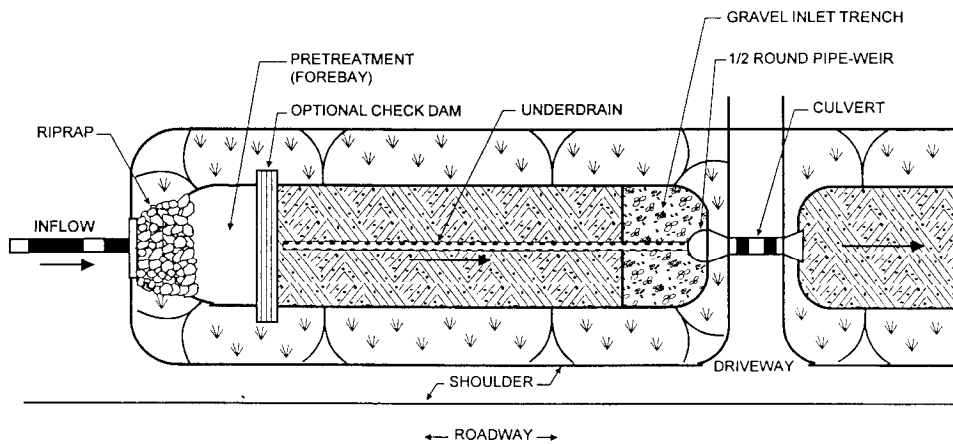

PLAN VIEW

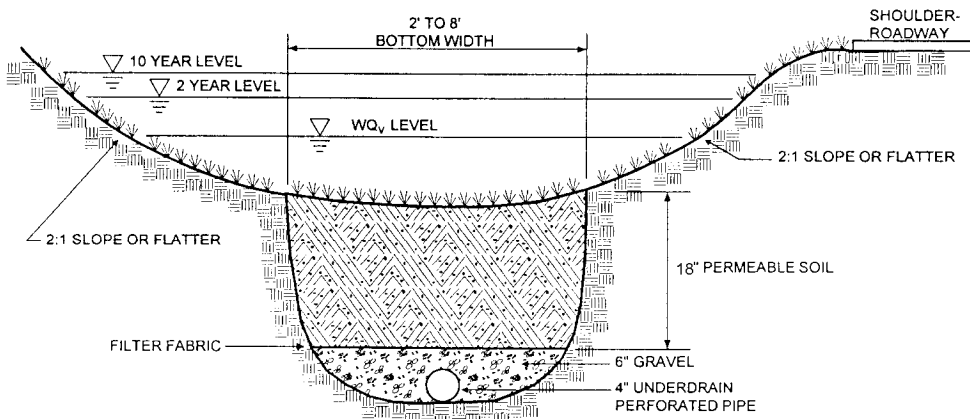

SECTION

Figure 5-10: Diagram of Grassy Swale with Check Dam (MDE, 2000).

General Criteria for Basic Swale Configuration

- (1) The swale should have a length that provides a minimum hydraulic residence time of at least 5 minutes. The maximum bottom width is 8 feet. If the flow is greater than that which can be handled by a single swale, consider installing drop inlets to a storm drain system at intervals to reduce the volume of runoff, or select a capture and treat type control. The depth of flow should not exceed 4 inches during a 0.6 inch/hour storm.

- (2) The channel slope should be at least 0.5% (200:1) and no greater than 2.5% (40:1), with maximum water velocities of 1.0 ft/s.
- (3) The swale can be sized as both a treatment facility for the design storm and as a conveyance system to pass the peak hydraulic flows of the 25-year storm if it is located “on-line.” Three inches of freeboard should be provided for the 25-year event.
- (4) The geometry of the channel is not critical as long as a broad, relatively flat bottom is provided. The side slopes should be no steeper than 2:1 (H:V).
- (5) Roadside ditches should be regarded as significant potential swale/buffer strip sites and should be utilized for this purpose whenever possible.
- (6) If flow is to be introduced through curb cuts, place pavement slightly above the elevation of the vegetated areas. Curb cuts should be at least 12 inches wide to prevent clogging.
- (7) Swales must have *at least* 80 percent vegetated cover in order to provide adequate stabilization of the swale invert. For general purposes, select fine, close-growing, water-resistant grasses.
- (8) Swales should generally not receive construction-stage runoff. If they do, pre-settling of sediments should be provided. Such swales should be evaluated for the need to remove sediments and restore vegetation following construction.
- (9) If possible, divert runoff (other than necessary irrigation) during the period of vegetation establishment. Where runoff diversion is not possible, cover graded and seeded areas with suitable erosion control materials.

General Criteria for Enhanced Swale Configuration

In the enhanced swale configuration all of the requirements listed above for the basic swale also apply. The following guidelines provide additional requirements.

- (1) At least 80% of the full length of the swale must be underlain with an engineered media and underdrain as shown in Figure 5-10 above and Figure 5-11 below. The specifications of the media composition are the same as required for bioretention.
- (2) If underdrains are used, the following parameters apply:
 - (a) The diameter of the underdrain should be between 4 and 6 inches, and installed in a gravel bed with at least 2 inches of gravel covering the top of the pipe.
 - (b) The underdrains should be perforated with $\frac{1}{4}$ - $\frac{1}{2}$ inch openings, 6 inches center to center. The pipes should have a minimum slope of 0.5%

(200:1). The underdrain pipe should have a cleanout access location. Ideally the cleanout access will be located in the facility embankment to reduce the possibility of bypass if the cleanout is damaged. All piping is to be Schedule 40 PVC

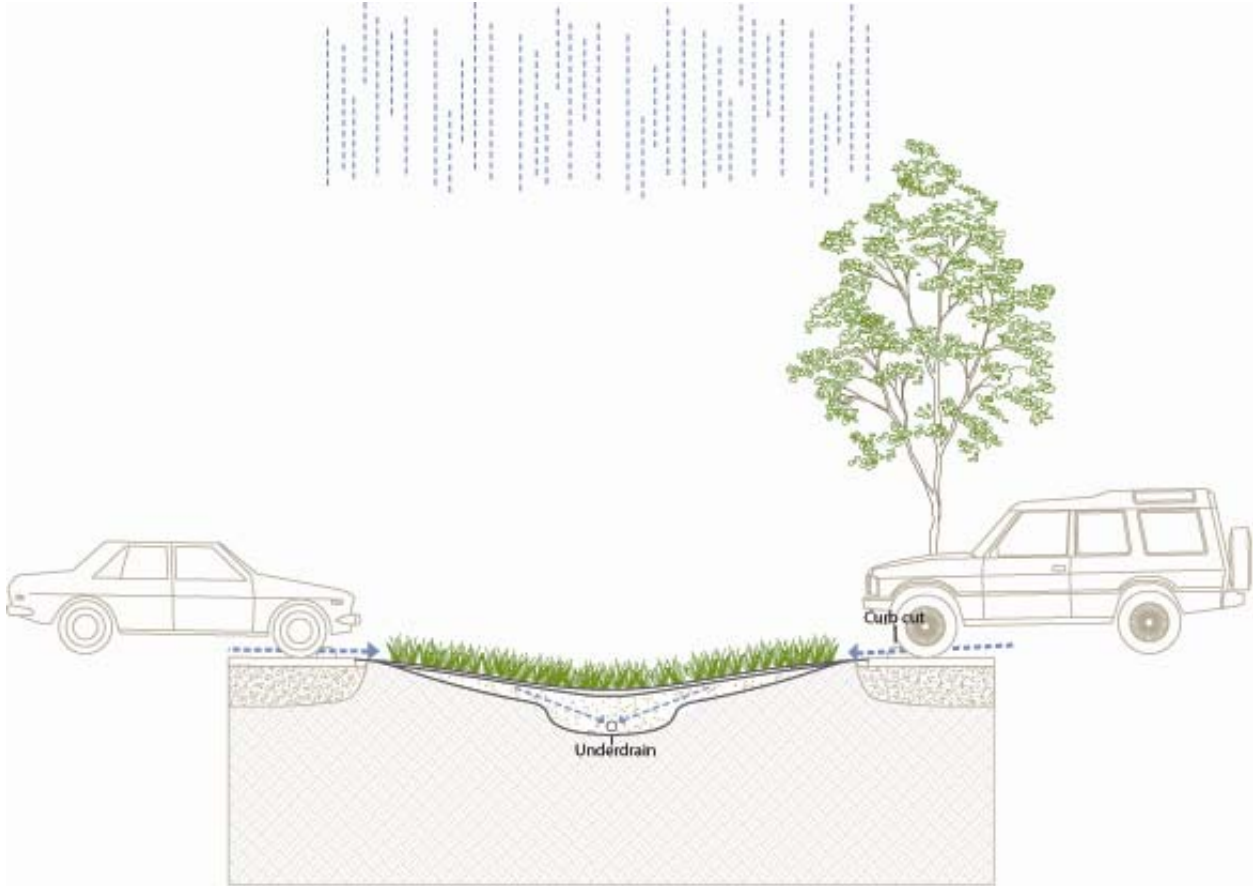

Figure 5-11: Enhanced swale diagram with underdrain system in parking lot.

Maintenance Requirements

Maintenance for grassy swales is minimal and is largely aimed at keeping the grass cover dense and vigorous. Maintenance practices and schedules should be developed and included as part of the original plans to alleviate maintenance problems in the future. Recommended practices include:

- *Pest Management.* An Integrated Pest Management (IPM) Plan should be developed for vegetated areas. This plan should specify how problem insects and weeds will be controlled with minimal or no use of insecticides and herbicides.
- *Seasonal Mowing and Lawn Care.* Lawn mowing should be performed routinely, as needed, throughout the growing season. Grass height should not exceed 18 inches.

Grass cuttings should be collected and disposed of offsite, or a mulching mower can be used. Regular mowing should also include weed control practices; however, herbicide use should be kept to a minimum. Healthy grass can be maintained without using fertilizers because runoff usually contains sufficient nutrients.

- *Inspection.* Inspect swales at least twice annually for erosion or damage to vegetation; however, additional inspection after periods of heavy runoff is most desirable. The swale should be checked for uniformity of grass cover, debris and litter, and areas of sediment accumulation. More frequent inspections of the grass cover during the first few years after establishment will help to determine if any problems are developing, and to plan for long-term restorative maintenance needs. Bare spots and areas of erosion identified during semi-annual inspections should be replanted and restored to meet specifications. Construction of a level spreader device may be necessary to reestablish shallow overland flow.
- *Debris and Litter Removal.* Trash tends to accumulate in swale areas, particularly along highways. Any swale structures (i.e. check dams) should be kept free of obstructions to reduce floatables being flushed downstream, and for aesthetic reasons. The need for this practice is determined through periodic inspection, but should be performed no less than two times per year.
- *Sediment Removal.* Sediment accumulating near culverts and in channels needs to be removed when they build up to 3 inches at any spot, or cover vegetation. Excess sediment should be removed by hand or with flat-bottomed shovels. If areas are eroded, they should be filled, compacted, and reseeded so that the final grade is level with the bottom of the swale. Sediment removal should be performed periodically, as determined through inspection.
- *Grass Reseeding and Mulching.* A healthy dense grass should be maintained in the channel and side slopes. Grass damaged during the sediment removal process should be promptly replaced using the same seed mix used during swale establishment. If possible, flow should be diverted from the damaged areas until the grass is firmly established.
- *Public Education.* Private homeowners are often responsible for roadside swale maintenance. Unfortunately, overzealous lawn care on the part of homeowners can present some problems. For example, mowing the swale too close to the ground, or excessive application of fertilizer and pesticides will all be detrimental to the performance of the swale. Pet waste can also be a problem in swales, and should be removed to avoid contamination from fecal coliform and other waste-associated bacteria. The delegation of maintenance responsibilities to individual landowners is a cost benefit to the locality. However, localities should provide an active educational program to encourage the recommended practices.

5.2.1 Plant Selection

Plant selection shall be made based on the desired function of the swale, the expected inundation period, and the aesthetic qualities of the LID BMP. Plants should be selected as dry, drought tolerant species that can handle long periods of inundation. Plants should NOT be wetland species. Grasses are the most appropriate option for both basic and enhanced swales.

Plants should be selected which:

- Are adapted to the soil type;
- Are suitable for their specific function (e.g. conveyance);
- Are durable, resilient and resistant to pests and disease;
- Are tolerant of the expected pollutant load in stormwater runoff ;
- Have a root system of the desired type, mass and depth;
- Are resistant to weed invasion;
- Require minimal maintenance; and
- Are not invasive.

Planting Considerations:

(1) *Plant Density*: Vegetated cover with herbaceous material should be at least 80% *once established* for both natural and enhanced swales, although 100% coverage is most desirable given the function of the swale. Unlike bioretention systems which can have a mix of grasses, forbs, and woody species leaving a small percentage of the ground cover uncovered, swales need to have full coverage of short grasses to properly convey runoff.

(2) *Biological activity*: It is important to plant a mix of cold and warm season grasses so the swale system maintains biological activity year-round.

(3) *Installation*: If any equipment has entered the swale or there have been any other means of compaction, it may be necessary to scarify the soil. Swales can be planted by seed or container plants. Supplemental irrigation is typically needed during the establishment phase.

(4) *Selection*: Ideal plants include any short grasses from the list of acceptable vegetation in Appendix B. Turf grasses will provide the best coverage (to reduce potential erosion issues) and function for the swale. A mix of turf grasses, rather than a singular species, will be most ideal.

5.3 Vegetated Filter Strips

Filter strips may be natural or engineered. The use of natural filter strips is limited to perimeter lots and other areas that will not drain by gravity to other BMPs on the site. Engineered filter strips achieve an 85% TSS removal efficiency in the first 15% of the area, and no concentration reduction after that.

Natural Filter Strips

- (1) The filter strip should extend along the entire length of the contributing area.
- (2) Slopes should be designed between 2% (50:1) and 6% (17:1). Flatter slopes can result in ponding runoff with the exception of very sandy or gravelly soils. The slope should not exceed 10% (10:1). Slopes greater than 10% (10:1) can result in the formation of concentrated flow (which can lead to rills and gullies). The minimum dimension (in the direction of flow) should be 50 feet.
- (3) All of the filter strip should lie above the elevation of the 2-yr, 3-hr storm of any adjacent drainage.
- (4) There is no strict requirement for vegetation type as natural filter strips are meant to be completely natural areas (e.g. no planting or maintenance).

Engineered Filter Strips

Many of the general criteria applied to swale design apply equally well to engineered vegetated filter strips. Vegetated roadside shoulders provide one of the best opportunities for incorporating filter strips into roadway and highway design as shown in Figure 5-13. The general design goal is to produce uniform, shallow overland flow across the entire filter strip. Landscaping on residential lots is not considered to function as a vegetated filter strip, because fertilizers and pesticides are commonly applied in these areas. In addition, all areas designated as engineered filter strips should be described in a legally binding document that restricts modification of these areas through an easement, setback, or other enforceable mechanism.

- (1) The filter strip should extend along the entire length of the contributing area and the slope should not exceed 20% (5:1). The minimum dimension of the filter strip (in the direction of flow) should be no less than 15 feet. The maximum width (in the direction of flow) of the contributing impervious area should not exceed 72 feet. For roadways with a vegetated strip along both sides the total width of the roadway should not exceed 144 feet (i.e., 72 feet draining to each side).
- (2) The minimum vegetated cover for engineered strips is 85%. Turf grasses should be used and should be a minimum of 2 inches high (City of Austin, 2003), and

native grasses should reach a minimum of 6 inches in height to ensure the flow across the VFS will not submerge them.

- (3) The area contributing runoff to a filter strip should be relatively flat so that the runoff is distributed evenly to the vegetated area without the use of a level spreader.
- (4) The area to be used for the strip should be free of gullies or rills that can concentrate overland flow (Schueler, 1987).
- (5) The top edge of the filter strip parallel to the pavement will be designed to avoid the situation where runoff would travel along the top of the filter strip, rather than through it.
- (6) Top edge of the filter strip should be level, otherwise runoff will tend to form a channel in the low spot. Use of level spreaders to distribute runoff to an engineered filter strip should be minimized as these systems have proven ineffective in many circumstances.
- (7) Filter strips should be landscaped after other portions of the project are completed.

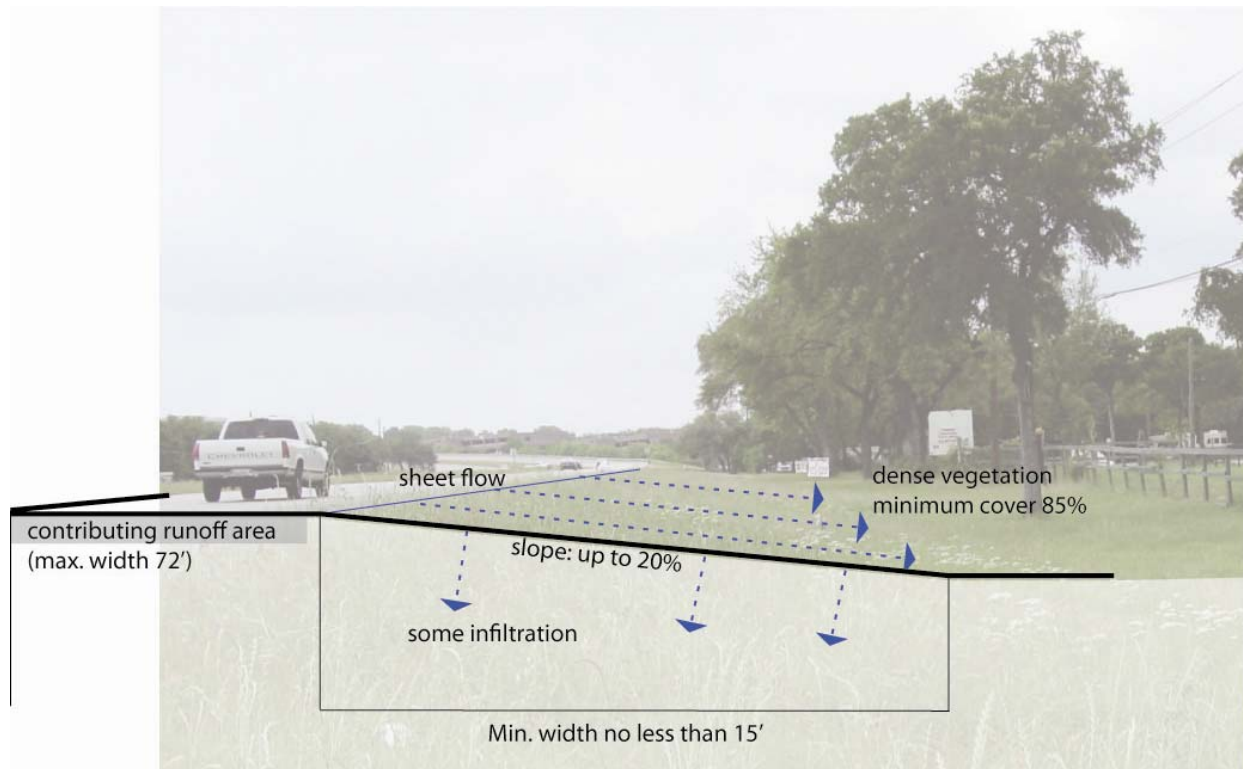

Figure 5-12: Engineered VFS in context.

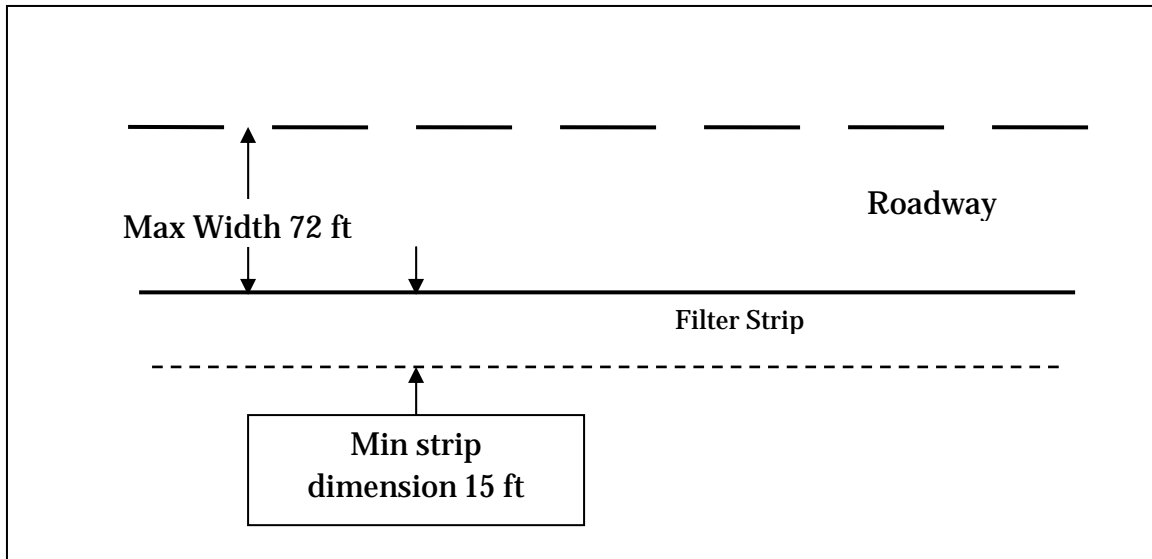

Figure 5-13: Example of filter strip along roadway in plan view.

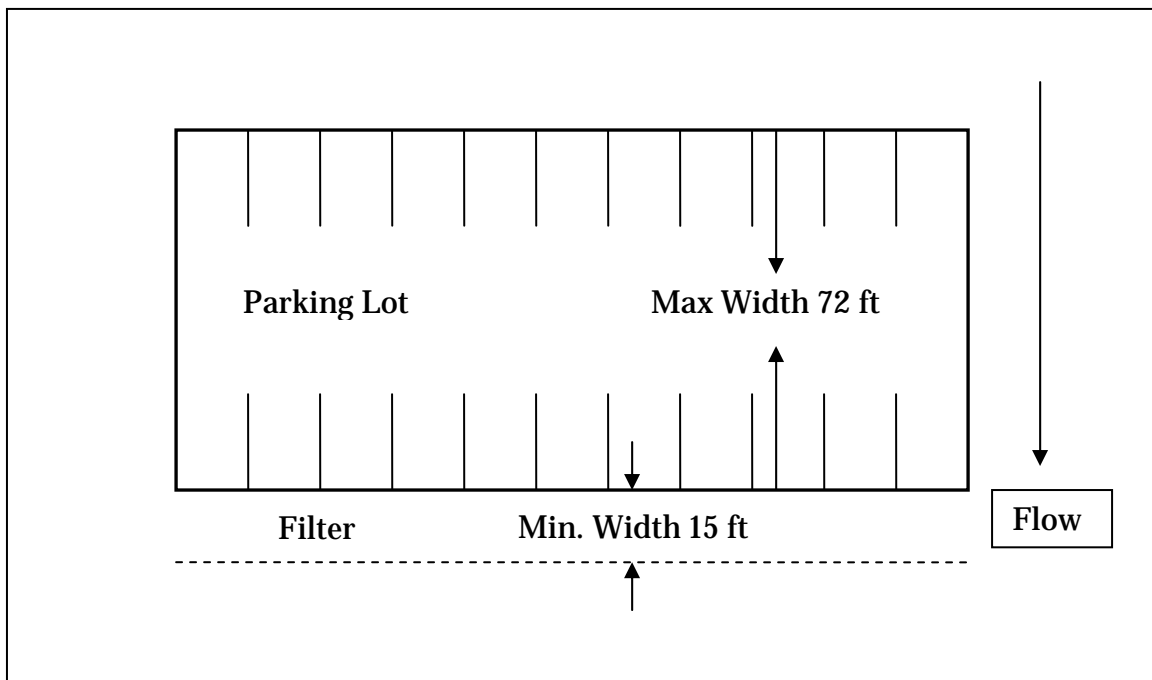

Figure 5-14: Example configuration of filter strip adjacent to parking lot in plan view.

Once a vegetated area is well established, little additional maintenance is generally necessary. The key to establishing a viable vegetated feature is the care and maintenance it receives in the first few months after it is planted.

- *Pre-establishment.* Prior to establishment, VFS require regular inspection to look for rills or gullies along the strip. It is also necessary to ensure that grasses have established. Inspections should be done once every week to two weeks during initial

establishment phase. More frequent inspections of the grass cover during the first few years after establishment will help to determine if any problems are developing, and to plan for long-term restorative maintenance needs. Irrigation of the site can help assure a dense and healthy vegetative cover.

Once established, all vegetated BMPs require some basic maintenance to insure the health of the plants including

- *Pest Management.* An Integrated Pest Management (IPM) Plan should be developed for vegetated areas. This plan should specify how problem insects and weeds will be controlled with minimal or no use of insecticides and herbicides. *Seasonal Mowing and Lawn Care.* If the filter strip is made up of turf grass, it should be mowed as needed to limit vegetation height to 18 inches, using a mulching mower (or removal of clippings). If native grasses are used, the filter may require less frequent mowing, once or twice a year. If the VFS contains denser or thicker vegetation, mowing may not be necessary at all, or once every few years to remove any unwanted growth. Grass clippings and brush debris should not be deposited on vegetated filter strip areas. Healthy grass can be maintained without using fertilizers because runoff usually contains sufficient nutrients. Any mowing should be done with minimum disruption to the soil and existing vegetation.
- *Inspection.* Inspect filter strips four times annually. However, additional inspection after periods of heavy runoff is most desirable as significant or continued rainfall events could lead to excess ponding. Inspection should be looking for several items:
 - Inspect twice during the growing and non-growing seasons for vegetation health, density and diversity. The strip should be checked for uniformity of grass cover. The vegetative cover needs to be maintained at 85% at a minimum. If the VFS becomes damaged and cover reduces to 50% or less, the area should be re-established.
 - Inspect for erosion, debris and litter, and areas of sediment accumulation. The area upstream from the VFS should be inspected several times a year for debris accumulation that could cause concentrated flows downstream.
 - Bare spots and areas of erosion identified during inspections must be replanted and restored to meet specifications.
- *Debris and Litter Removal.* Trash tends to accumulate in vegetated areas, particularly along highways. Any filter strip structures (i.e. level spreaders) should be kept free of obstructions to reduce floatables being flushed downstream, and for aesthetic reasons. The need for this practice is determined through periodic inspection, but should be performed no less than 4 times per year.
- *Sediment Removal.* Sediment removal is not normally required in filter strips, since the vegetation normally grows through it and binds it to the soil. However, sediment may accumulate along the upstream boundary of the strip preventing uniform overland flow. Excess sediment should be removed by hand or with flat-bottomed

shovels. If sediment has accumulated at the top of the strip to 25% or more of the VFS' capacity, it needs to be removed immediately.

- *Grass Reseeding and Mulching.* A healthy dense grass should be maintained on the filter strip as described above. Grass damaged during any sediment removal processes should be promptly replaced using the same seed mix used during filter strip establishment. If possible, flow should be diverted from the damaged areas until the grass is firmly established. Bare spots and areas of erosion identified during semi-annual inspections must be replanted and restored to meet specifications. These areas should be re-vegetated so that the final grade is level. Corrective maintenance, such as weeding or replanting should be done more frequently in the first two to three years after installation to ensure stabilization. Dense vegetation may require irrigation immediately after planting, and during particularly dry periods.

5.3.1 Plant Selection

Grasses and forbs within the VFS should be regionally appropriate and able to withstand both wet and dry periods. In San Antonio, drought tolerant grasses should be used to minimize irrigation requirements and withstand the rigors of the regional climate. Native grass is highly recommended for its ability to filter and infiltrate runoff pollutants efficiently (City of Austin, 2003). A healthy mix of grasses and forbs from the list provided in Appendix B will provide a robust aesthetic as well.

5.4 Porous Pavement

Porous pavement systems consist of a pervious surface on top of a stone base, often referred to as the stone reservoir, which stores runoff before it infiltrates into the underlying soil (Figure 5-19). The use of permeable pavement techniques will be dictated by local or regional regulations but are often allowed in pedestrian areas (sidewalks, patios, plazas) and in some cases, for certain parking areas such as in stalls or overflow areas. For additional application areas of porous pavement, such as roadways, please review local guidance.

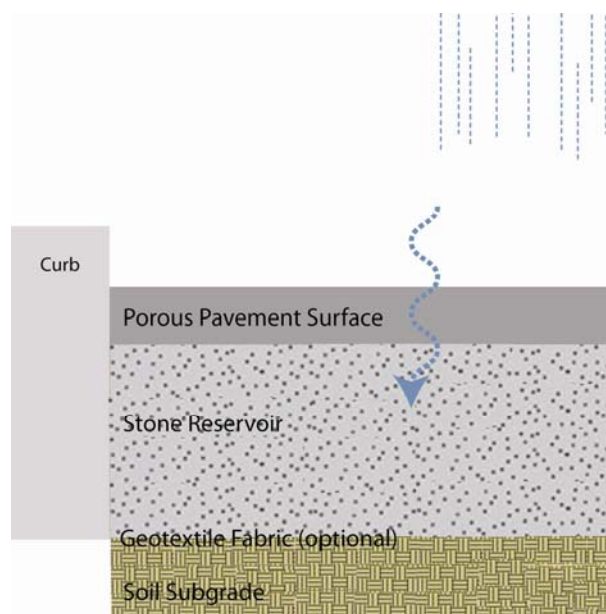

Figure 5-15: Basic components of a porous pavement system.

Recommended design guidelines for porous pavement include the following elements:

- (1) As part of the site evaluation take soil boring to a depth of at least 4 feet below the bottom of the stone reservoir to check for soil permeability, porosity, depth of seasonally high water table, and depth to bedrock.
- (2) Not recommended on slopes greater than 5 percent and best with slopes as flat as possible.
- (3) Minimum infiltration rate of 0.5 inches per hour. In circumstances with lower infiltration rates, it is possible to add an underdrain system underneath the reservoir. While this will reduce the volume reduction benefits, it will still provide benefits of a slower release time to downstream waterbodies.
- (4) Minimum depth to bedrock and seasonally high water table: 4 feet.

- (5) Minimum setback from water supply wells: 100 feet.
- (6) Minimum setback from building foundations: 10 feet down gradient, 100 feet upgradient.
- (7) Not recommended in areas where wind erosion supplies significant amounts of windblown sediment.
- (8) Drainage area should be less than 15 acres.
- (9) Use for low-volume automobile parking areas and lightly used access roads.
- (10) Avoid moderate to high traffic areas and significant truck traffic.
- (11) Highly variable; depends upon regulatory requirements. Typically design for storm water runoff volume produced in the tributary watershed by the 6-month, 24-hour duration storm event.
- (12) Drainage time for design storm: Minimum: 12 hours; Maximum: 72 hours; Recommended: 24 hours. The drainage time refers to discharge of runoff from the entire system, including the reservoir course.
- (13) Excavate and grade with light equipment with tracks or oversized tires to prevent soil compaction.
- (14) As needed, divert storm water runoff away from planned pavement area before and during construction.
- (15) A typical porous pavement cross-section consists of the following layers: 1) porous asphalt course, 2-4 inches thick; 2) filter aggregate course; 3) reservoir course of 1.5-3-inch diameter stone; and 4) filter fabric (optional).
- (16) As recommended by manufacturer.

Operation and Maintenance

Porous pavements need to be maintained. Maintenance should include vacuum sweeping at least four times a year (with proper disposal of removed material), followed by high-pressure hosing to free pores in the top layer from clogging. Potholes and cracks can be filled with patching mixes unless more than 10 percent of the surface area needs repair. Spot-clogging may be fixed by drilling half-inch holes through the porous pavement layer every few feet. The pavement should be inspected several times during the first few months following installation and annually thereafter. Annual inspections should take place after large storms, when puddles will make any clogging obvious. The condition of adjacent pretreatment devices should also be inspected.

6 References

Collins, O. B., F. E. Smeins, and D. H. Riskind. 1975. Plant Communities of the Blackland Prairie of Texas. Pages 75-88 *in* M. K. Wali, editor. *Prairie: a Multiple View; Fourth North American Prairie Conference*. University of North Dakota Press, Grand Forks, North Dakota.

Diamond, D.D. and F.E. Smeins. 1993. The native plant communities of the Blackland Prairie. In: Sharpless, M.R. and J.C. Yelderman (eds.). *The Texas Blackland Prairie, land, history, and culture*. Baylor University, Program for Regional Studies, Waco, Texas. pp. 66-81.

Griffith, G.E., S.A. Bryce, J.M. Omernik, J.A. Comstock, A.C. Rogers, B. Harrison, S.L. Hatch, and D. Bezanson. 2004. Ecoregions of Texas. (2 sided color poster with map, descriptive text, summary tables, and photographs). U.S. Geological Survey, Reston, Virginia. Scale 1:2,500,000.

North Central Texas Council of Governments. Integrated Stormwater Management, iSWM™ Technical Manual. Revised April 2010. <http://iswm.nctcog.org/index.asp>

Maryland Department of the Environment, 2000, Maryland Stormwater Design Manual, accessed 7/6/11 at: http://www.mde.state.md.us/programs/Water/StormwaterManagementProgram/MarylandStormwaterDesignManual/Pages/Programs/WaterPrograms/SedimentandStormwater/stormwater_design/index.aspx

New York Department of Environmental Conservation, undated, Better Site Design, accessed 6/29/11 at: <ftp://ftp.dec.state.ny.us/dow/stormdocuments/design-guidance/Better%20Site%20Design-final.pdf>

Oberndorfer, E., Lundholm, J., Bass, B., Coffman, R., Doshi, H., Dunnett, N., Gaffin, S., Kohler, M., Liu, K., Rowe, B. 2007. *Green Roofs as Urban Ecosystems: Ecological Structures, Functions, and Services* *BioScience*, 57(10): 823-833.

Riskind, D. H., and O. B. Collins. 1975. The Blackland Prairie of Texas: Conservation of Representative Climax Remnants. Pages 361-367 *in* M. K. Wali, editor. *Prairie: a Multiple View; Fourth North American Prairie Conference*. University of North Dakota Press, Grand Forks, North Dakota. Sustainable Sites Initiative. 2009.

U.S. EPA, 1999, Storm Water Technology Fact Sheet: Porous Pavement, Report EPA 832-F-99-023, Office of Water, Washington DC

U.S. EPA, 2005, Economic Benefits of Runoff Controls, Report EPA 851-S-95-002, Office of Wetlands, Oceans, and Watersheds, Accessed 6/16/2011 at: <http://www.epa.gov/owow/NPS/runoff.html>

U.S. EPA, 2007, Reducing Stormwater Costs through Low Impact Development (LID) Strategies and Practices, Report EPA 841-F-07-006, Nonpoint Source Control Branch, Washington DC, Accessed 6/16/2011 at: <http://www.epa.gov/owow/NPS/lid/costs07/documents/reducingstormwatercosts.pdf>

U.S. EPA, 2008, Design Principles for Stormwater Management on Compacted, Contaminated Soils in Dense Urban Areas, Report EPA 560-F-07-231, Accessed 6/16/2011 at: <http://www.epa.gov/brownfields/tools/swdp0408.pdf>

U.S. EPA, 2008, Managing Wet Weather with Green Infrastructure Municipal Handbook: Rainwater Harvesting Policies, prepared by C. Kloss at the Low Impact Development Center, EPA Report EPA-833-F-08-010, Accessed 7/7/2011 at: <http://nepis.epa.gov/Exe/ZyNET.exe/P1005FN2.TXT?ZyActionD=ZyDocument&Client=EPA&Index=2006+Thru+2010&File=D%3A\ZYFILES\INDEX+DATA\06THRU10\TX\00000011\P1005FN2.TXT&User=anonymous&Password=anonymous&ImageQuality=r85g16%2Fr85g16%2Fy150y150g16%2Fi500&Display=hpfrw&Back=ZyActionS&MaximumPages=5&Query=fname%3D%22P1005FN2.TXT%22#>

Appendix A: Definitions & Acronyms

LID: Low Impact Development

BMP: Best Management Practice

NPS: Nonpoint Source Pollution

TCEQ: Texas Commission on Environmental Quality

EPA: Environmental Protection Agency

HOA: Homeowners Association

ROW: Right-of-way

WQV: Water Quality Volume

Filtration: The sequestration of sediment and other pollutants from stormwater runoff by the movement of runoff across a vegetated area and through media.

Infiltration: The vertical movement of stormwater runoff through plants and soil; and in unlined systems, recharging groundwater.

Detention: The temporary storage of stormwater runoff (in ponds, underground systems or depressed areas) to allow for controlled discharge at a later time.

Retention: The storage of stormwater runoff on site (and not released at a later time, but possibly used for an additional purpose such as irrigation).

Evapotranspiration: the combined amount of evaporation and plant transpiration from the earth's surfaces to the atmosphere.

Sedimentation: The process whereby suspended material settles out of a liquid in which they are transported. Suspended materials includes particles, such as clay or silt, which are dropped by gravity from the liquid once the velocity is decreased to a point below which the particles can remain in suspension.

Bioretention & Rain Gardens: These are landscaping features adapted to provide on-site treatment of stormwater runoff. They function as a soil and plant-based filtration device that removes pollutants through a variety of physical, biological, and chemical treatment processes. These facilities can consist of a buffer strip, sand bed, ponding area, organic layer or mulch layer, planting soil, and plants.

Filtration Media (aka, planting bed, growing medium): The soil media (native, amended or manufactured) in the vegetated BMPs which support vegetation growth and provide water filtration.

Green Roofs: A green roof is a roof that is partially or completely covered with vegetation.

Swales: A vegetated swale is a broad, shallow channel with a dense stand of vegetation covering the side slopes and bottom. Swales can be natural or manmade, and are designed to trap particulate pollutants, promote infiltration, and reduce the flow velocity of storm water runoff.

Porous Pavement: Porous pavement is a permeable pavement surface with a stone reservoir underneath. Porous pavement often appears the same as traditional asphalt or concrete but is manufactured without "fine" materials, and instead incorporates void spaces that allow for infiltration.

Reservoir Course (or Stone Reservoir): A stone layer typically found underneath the permeable paving system. It is the base course that doubles as a reservoir for the stormwater before it infiltrates into the underlying soil.

Rainwater Harvesting: Rainwater harvesting is the accumulation and storage of rainwater for reuse. Typically, rooftop runoff is collected into cisterns or barrels and water can be used at a later point for irrigation, non-potable indoor uses or in more advanced application, potable uses.

Vegetated Filter Strips: are evenly sloped vegetated areas that treat stormwater runoff from adjacent surfaces, flowing through it as sheet flow, by filtering it through vegetation. VFS slow runoff velocities, provide some infiltration, and filter out sediment and other pollutants.

Ponding depth: The determined allowable depth of water able to pond at the surface of the BMP. Ponding depth influences the sizing of the BMP.

Sorption: Sorption refers to the processes of adsorption and absorption. Adsorption is the physical bonding of ions or molecules onto the surface of another molecule. Absorption is the incorporation of a substance in one state into another substance of a different state. For example, in processes of remediation, adsorption refers to the attraction between the outer surface of a solid particle and a contaminant, where the contaminant assimilates on the surface. In a similar condition, absorption refers to the uptake of the contaminant into the structure of the solid particle, where the contaminant permeates another substance.

Appendix B: Plants

The following pages list tree, grass and forb species suitable for various LID practices. Please note that this list:

- Is not exclusive and other regionally appropriate species may also be appropriate for LID;
- Is a work in progress and that San Antonio should update this list as necessary from local, tested projects; and
- Only contains native plants.

Additional locations for, and links to, plant resources is provided on the next page.

Suitable Species for LID features

Plants are specified suitable for a region based upon local ecological conditions. If making amendments to the soil, plant selection should be made accordingly.

For more detailed information about individual plants, please visit the Native Plant Information Network(NPIN) at <http://www.wildflower.org/explore/>. To find a plant's county-by-county distribution, please search the USDA's Plants Database at: <http://plants.usda.gov/>. This link is also provided on the individual plant page on NPIN.

In order to maximize the effectiveness of your biofiltration features, we suggest mixing warm and cool season plants for year-round biological activity.

The majority of the listed plants are commercially available by seed. To find native plant suppliers in your area: <http://www.wildflower.org/suppliers/>

Please consider whether or not native soils will be modified - which will affect infiltration rates - when choosing plants.

Grass Species

<i>Botanical Name</i>	Common Name	Light Requirement	Season/Type/ComAvail.	Comments
<i>Andropogon gerardii</i>	Big bluestem	Sun/Part Shade	Warm/Grass/Yes	4'-8' tall, conspicuous flowers and foliage
<i>Andropogon virginicus L.</i>	Broomsedge bluestem	Part Shade	Warm/Grass/Yes	Can be an invader on disturbed land, Moist soil, attractive
<i>Bouteloua dactyloides</i>	Buffalograss	Sun	Cool/Grass/Yes	Very drought tolerant; can withstand short-term saturation; loam, clay, caliche, or limestone. Does not like sand.
<i>Andropogon glomeratus</i>	Bushy bluestem	Sun	Warm/Grass/Yes	2'-5' Moist, low-lying areas, with year-round color. Best in wet areas
<i>Elymus Canadensis</i>	Canada wildrye	Sun, Part Shade	Cool/Grass/Yes	Good cool season bunch grass for part shade
<i>Eleocharis palustris</i>	Common spikerush	Part Shade	Warm/Grass/Yes	Can tolerate dry periods. Excellent shore stabilization
<i>Carex blanda</i>	Eastern Woodland Sedge	Sun/PS/Shade	Warm/Grass/Yes	Moist to dry soils, well drained, frequent along creek and river terraces

Botanical Name	Common Name	Light Requirement	Season/Type/ComAvail.	Comments
<i>Carex emoryi</i>	Emory's sedge	Sun	Warm/Grass	Good for bank Stabilization, has dense root mass. Lower drought tolerance.
<i>Equisetum hyemale</i>	Horsetail	Sun/PS/Shade	Forb/Yes	Evergreen. Can be invasive. Bod or Pond applicton
<i>Chasmanthium latifolium</i>	Inland sea oats	Part Shade / Shade	Warm/Grass/Yes	Good low maintenance shade grass.
<i>Eragrostis spectabilis</i>	Purple Lovegrass	Sun	Warm/Grass/Yes	1.5' tall, moist sandy soils, well-drained
<i>Bouteloua curtipendula</i>	Sideoats grama	Sun/Part Shade	Warm/Grass/Yes	1'-3' attractive grass
<i>Eleocharis quadrangulata</i>	Squarestem spikerush	Sun	Warm/Grass	Lower drought tolerance.
<i>Elymus virginicus</i>	Virginia wildrye	Part Shade	Grass/Varies	
<i>Melica nitens</i>	Three-Flower Melic	Part Shade	Warm/Grass/Yes	1'-3' tall, moist to dry soils, well-drained, rocky or sandy, a shade loving grass
<i>Muhlenbergia lindheimeri</i>	Big Muhly	Sun	Warm/Grass/Yes	2'-5' bunchgrass, moist to dry soils, well-drained, rocky, limestone soils
<i>Muhlenbergia reverchonii</i>	Seep Muhly	Sun	Warm/Grass/Yes	6" Tall, Moist to dry soils, rocky, gravelly, or loamy limestone
<i>Panicum virgatum</i>	Upland Switchgrass	Sun/Part Shade	Warm/Grass/Yes	A good choice ecologically, can get tall. Please specify Upland Switchgrass and not Lowland Switchgrass
<i>Paspalum distichum</i>	Knotgrass	Sun	Warm/Gras	Lower drought tolerance.
<i>Pluchea odorata</i>	Marsh fleabane	Sun/PS/Shade	Warm/Sub Shrub	Late season color. Lower drought tolerance.
<i>Schizachyrium scoparium</i>	Little bluestem	Sun/Part Shade	Warm/Grass/Yes	Well drained soil, lower inundation tolerance.
<i>Setaria parviflora</i>	Knotroot bristlegrass	Part Shade	Warm/Grass	

<i>Sorghastrum nutans</i>	Indian grass	Sun/PS/Shade	Warm/Grass/Yes	Best if planted en masse. Withstands shorter periods of inundation.
<i>Sporobolus airoides</i>	Alkali sacaton	Part Shade	Warm/Grass/Yes	Dust control and soil protection on saline-alkaline soils.
<i>Sporobolus compositus</i> <i>var. compositus</i>	Composite Dropseed	Sun	Warm/Grass/Yes	2'-4' bunchgrass, moist, sandy soils
<i>Tripsacum dactyloides</i>	Eastern gamagrass	Part Shade	Warm/Grass	2'-3', Moist soils, conspicuous flowers and foliage, needs space and to be cut back in winter.

Forb Species

Botanical Name	Common Name	Light Requirement	Season/Type/ComAvail.	Comments
<i>Aquilegia canadensis</i>	Eastern Red Columbine	Part Shade to Shade	Warm/Forb/Yes	2', Moist to Dry sandy, well drained soils, shade loving perennial
<i>Asclepias asperula</i>	Spider Milkweed	Sun	Warm/Forb?Yes	1'-2' Tall, moist to dry soils, prefers rocky or sandy soils of prairies
<i>Asclepias tuberosa</i>	Butterfly Weed	Sun to Part Shade	Warm/Forb/Yes	1'-2' perennial, moist to dry well drained soils
<i>Asclepias viridis</i>	Green Antelopehorn	Sun	Warm/Forb/Yes	Moist soils, grows in rich or poor soils and blooms off and on over their growing season, requires little water
<i>Callirhoe involucrata</i>	Winecup	Sun to Part Shade	Warm/Forb/Yes	up to 3', moist to dry soils, well drained, rocky or sandy soils, sasses of flowers in the spring
<i>Callirhoe pedata</i>	Finger Poppy-Mallow	Sun to Part Shade	Warm/Forb/Yes	Moist to dry soils, excellent mixed with short grasses, more shade tolerant than other winecups
<i>Capsicum annuum</i>	Chile Pequin	Sun/PS/Shade	Warm/Forb/Yes	Moist, clay and heavy clay, sandy loam, edible hot pepper

Botanical Name	Common Name	Light Requirement	Season/Type/ComAvail.	Comments
<i>Calyptocarpus vialis</i>	Horseherb	Sun/PS/Shade	Warm/Forb/Yes	Good shade groundcover. May disappear in heat of summer.
<i>Castilleja indivisa</i>	Indian Paintbrush	Sun	Warm Annual/Forb/Yes	Dry Acidic soils, open, sunny sites only by seed, require a cold wet period in the winter
<i>Chamaecrista fasciculata</i>	Partridge Pea	Sun to Part Shade	Annua/Forb/Yes	1-3' Annual, moist to dry, sandy, well drained soil
<i>Conoclinium coelestinum</i>	Blue mistflower	Sun Part Shade	Warm/Forb/Yes	Spreads quickly, late season butterflies.
<i>Cooperia drummondii</i>	Evening Rain Lily	Sun to Part Shade	Warm/Forb/?	1' tall, Moist to dry, clay to clay loam, white flowers appear after rain events, naturalizes well in a lawn
<i>Cooperia pedunculata</i>	Hill Country Rain Lily	Sun	Warm/Forb/Yes	Moist, clay to clay loam soils, flower after rain events, combine well with plants with short foliage
<i>Coreopsis tinctoria</i>	Plains coreopsis	Sun/Part Shade	Warm Annual/Forb/Yes	Moist sandy soils, high water use, showy flowers
<i>Echinacea pallida</i>	Pale purple coneflower	Sun	Warm/Forb/Yes	Alkaline to acidic, drought tolerant, moist to dry soils.
<i>Gaillardia pulchella</i>	Indian Blanket	Sun/Part Shade	Annual/Forb/Yes	Easy wildflower to begin in meadow. Best in higher areas that are well-drained
<i>Helenium amarum</i>	Bitterweed	Sun/Part Shade	Annual/Forb	Sand, loam, clay, limestone; acid or calcarerous, well drained or poor drainage.
<i>Helianthus maximiliani</i>	Maximilian sunflower	Sun	Warm/Forb/Yes	Heavy seed crop good for wildlife. Withstands short-term saturation.
<i>Justicia americana</i>	American Water-willow	Sun/Part Shade	Warm/Forb/Yes	Wet/Moist Soil, Lower drought tolerance

Botanical Name	Common Name	Light Requirement	Season/Type/ComAvail.	Comments
<i>Liatris elegans</i>	Gay feather	Sun	Warm/Forb	Dry, sandy or rocky soils
<i> Lobelia cardinalis</i>	Cardinal flower	Sun/PS/Shade	Warm/Forb/Yes	Attracts Humming Birds and Butterflies. Prefers wet locations
<i>Malvaviscus arboreus var. drummondii</i>	turk's cap	Shade/Part Shade	Warm/Forb/Yes	Moist, well-drained, woodland soils best. Also drought tolerant
<i>Monarda citriodora</i>	Lemon beebalm	Sun/Part Shade	Cool Annual/Forb/Yes	Dry, sandy loam to rocky soils
<i>Monarda punctata</i>	Spotted beebalm	Sun	Warm Annual/Forb/Yes	Dry, sandy, circumneutral soils, lower drought tolerance.
<i>Oenothera speciosa</i>	Pink evening primrose	Sun	Warm/Forb/Yes	Moist, Dry, wide range of soils, dormant in dry summer, showy flowers, can work as a dense foliage groundcover
<i>Penstemon cobaea</i>	Wild foxglove	Sun/Part Shade	Warm/Forb/Yes	Dry, acid, calcareous or sandy loam. May go dormant in dry summer
<i>Phlox drummondii</i>	Annual phlox	Sun/Part Shade	Warm Annual/Forb/Yes	Dry, acidic to circumneutral , well drained soils
<i>Phlox pilosa</i>	Downy phlox	Sun/Part Shade	Warm/Forb/Yes	Dry, acid, well-drained soils, conspicuous flowers
<i>Phyla nodiflora</i>	Frogfruit	Sun/Part Shade	Warm/Forb/Yes	creeping perennial; dry to moist, sand, loam, clay, acid or calcareous; poor drainage
<i>Ratibida columnifera</i>	Mexican hat	Sun	Warm/Forb/Yes	Moist, dry, various well-drained soils, fast growing
<i>Rivina humilis</i>	Pigeonberry	Part Shade	Warm/Forb/Yes	Fruit & Leaves toxic if ingested, fruit attract birds. Lower inundation tolerance.
<i>Rudbeckia hirta</i>	Black-eyed Susan	Sun/PS/Shade	Warm/Forb/Yes	Lower inundation tolerance
<i>Salvia coccinea</i>	Scarlet sage	Sun/PS/Shade	Warm/Forb/Yes	Moist, dry, easily grown
<i>Salvia engelmannii</i>	Engelmann's Sage	Sun to Part Shade	Warm/Forb/Yes	Moist to dry soils, well-drained, rocky, sandy soils

Botanical Name	Common Name	Light Requirement	Season/Type/ComAvail.	Comments
<i>Salvia farinacea</i>	Mealy Blue Sage	Sun	Warm/Forb/Yes	2'-3' mounding plant, moist limestone soils, deer resistant, blooms throughout summer
<i>Solidago altissima</i>	Tall goldenrod	Part Shade/Shade	Warm/Forb/Yes	Attracts butterflies and birds. Late season color.
<i>Symphotrichum praealtum</i>	Tall aster	Sun/PS/Shade	Warm/Forb	
<i>Teucrium canadense</i>	Canada germander	Part Shade	Warm/Forb	Moist or submerged soils. Can work in shady areas.
<i>Thelypteris kunthii</i>	Wood Fern	Shade/Part Shade	Warm/Fern/Yes	Moist, sand, loam, clay, or limestone. Poor drainage okay
<i>Tradescantia spp.</i>	Spiderwort	Sun to Part Shade	Warm/Forb/Yes	Dry to moist sandy soils, well-drained
<i>Vernonia baldwinii</i>	Baldwin's Ironweed	Sun	Warm/Forb/?	3'-5' Tall, Moist, rocky or sandy soils, bloom last from summer to frost
<i>Wedelia texana</i>	Wedelia	Sun to Part Shade	Warm/Forb/Yes	1'-3', moist to dry, well-drained soils, long-lived, drought tolerant

Suitable Species for LID Features

Plants are specified suitable for a region based upon local ecological conditions. If making amendments to the soil, plant selection should be made accordingly.

For more detailed information about individual plants, please visit the Native Plant Information Network(NPIN) : <http://www.wildflower.org/explore/>. To find a plants' county-by-county distribution search the USDA's Plants Database: <http://plants.usda.gov/>. This link is also provided on the individual plant page on NPIN.

In order to maximize the effectiveness of your biofiltration features, we suggest mixing warm and cool season plants for year-round biological activity.

The majority of the listed plants are commercially available by seed. To find native plant suppliers in your area: <http://www.wildflower.org/suppliers/>

Please consider whether or not native soils will be modified - which will affect infiltration rates - when choosing plants.

Tree species

Botanical Name	Common Name	Size (large/Small)	Comments
<i>Acacia smallii</i>	Huisache	15'-25'	
<i>Acer negundo</i>	Boxelder	35'-60' (Small/Medium)	Susceptible to wind and ice damage
<i>Callicarpa americana</i>	American Beautyberry	3'-6' Shrub	Part Shade, moist, rich soils, large understory shrub, naturally loose and graceful arching form. Branches laden with magenta purple berry clusters in the fall
<i>Carya illinoensis</i>	Pecan	70'-100'	Sun, rich, moist, well-drained soils, excellent nut and shade tree
<i>Celtis laevigata</i>	Sugar Hackberry	60'-80'	Part Shade, Moist to dry soils, Sandy, sand loam, street tree in the South, native to stream banks
<i>Cephalanthus occidentalis</i>	Buttonbush	6'-12' Shrub	Showy, attractive shrub for moist or poorly drained soils. Lower drought tolerance.
<i>Cercis canadensis</i>	Eastern Redbud	12-36'	Part Shade to Shade, Moist, fertile, well-drained soils
<i>Chilopsis linearis</i>	Desert Willow	15'-40'	Sun, Moist to dry, well-drained limestone soils preferred, more of an edge plant, not bottomlands in
<i>Cornus drummondii</i>	Roughleaf Dogwood	12'-16' Shrub/Small Tree	Adaptable from wet to dry, Fall conspicuous, attracts butterflies and birds.
<i>Diospyros texana</i>	Texas Persimmon	10'-15' Shrub/Small Tree	High drought tolerance, dry, alkaline soils, sun, attracts birds and butterflies. Withstands short period saturation.
<i>Diospyros virginiana</i>	Common Persimmon	10'-15' Shrub/Small Tree	High drought tolerance, dry, alkaline soils, sun, attracts birds and butterflies. Withstands short period saturation.
<i>Ehretia anacua</i>	Anacua	20'-45'	Sun to Part Shade, dry, well-drained, drought tolerant
<i>Frangula caroliniana</i>	Carolina Buckthorn	12'-15'	Part Shade, moist, calcareous or rocky soils. Ripe berries attract birds. More of a bottomland plant
<i>Fraxinus pennsylvanica</i>	Green Ash	36'-72' Large	Shade tree, fast growing, Fall conspicuous.

Tree species

Botanical Name	Common Name	Size (large/Small)	Comments
<i>Ilex decidua</i>	Possum-haw	15'-30' Shrub/Small Tree	Female tress have conspicuous red berries in Winter, Accent tree/shrub, present in some river bottoms.
<i>Ilex vomitoria</i>	Yaupon	12'-25' Shrub/S. Tree	Sun/PS/Shade, well drained, tolerates drought and poor drainage, female red berries
<i>Juglans nigra</i>	Black Walnut	50'-75' Large	Fall conspicuous foliage, Shade tree
<i>Juniperus virginiana</i>	Eastern red cedar	30-40' Medium/Large	Sun/PS/Shade, dry soils, heat and cold tolerant
<i>Mahonia trifoliolata</i>	Agarito	3'-6' Shrub	Sun to Part Shade, Moist to dry rocky, limestone soils,
<i>Morus rubra</i>	Red Mulberry	12'-36' Medium	Understory tree, attractive fall foliage, unripe fruit are toxic if consumed
<i>Parkinsonia aculeata</i>	Retama	12'-36'	Sun, Moist to Dry soils, medium drought tolerance, heat tolerant, fast-growing tree
<i>Platanus occidentalis</i>	Sycamore	75'-100' Large	Large deciduous shade tree
<i>Prunus mexicana</i>	Mexican Plum	15'-35' Small	Sun/PS, Moist, dry, well-drained soils, accent tree or shrub
<i>Quercus fusiformis</i>	Texas Live Oak	20'-40' Small/Medium	Dry soils, heat, colt, and drought tolerant shade tree
<i>Quercus shumardii</i>	Shumard Oak	50'-90' Large	Sun/PS, moist, dry soil, drought resistant and withstands short-term flooding, provides good fall foliage
<i>Quercus stellata</i>	Post Oak	40'-50' Large	Part shade, dry to moist rocky or sandy soils, very drought resistant, long-lived
<i>Quercus virginiana</i>	Live Oak	60'-100' Large	Sun/Part Shade; dry to moist soils, sand, loam, clay; best in neutral or slightly acidic clay loams; tolerates poor drainage
<i>Sapindus saponaria var. drummondii</i>	Soapberry	10'-50'	Sun to part shade, moist to dry, rich, limestone soils
<i>Sophora secundiflora</i>	Texas Mountain Laurel	10'-15'	Sun to Part Shade, moist to dry well-drained soils, alkaline, CaCO2 tolerant, heat and cold hardy, evergreen foliage and showy flowers, red seeds are poisonous
<i>Taxodium distichum</i>	Bald Cypress	50'-75' Large	Moist acidic soils, fall conspicuous foliage
<i>Ulmus americana</i>	American Elm	60'-80' Large	Sun to Part Shade, moist, well drained soils, fertile, susceptible to Dutch Elm Disease
<i>Ulmus crassifolia</i>	Cedar Elm	30'-60' Medium/Large	Shade tree, Fast growing, Long-living, Fall conspicuous

