

A framework for sustainability analysis in water resources management and application to the Syr Darya Basin

Ximing Cai

International Food Policy Research Institute, Washington, D. C., USA

Daene C. McKinney

Department of Civil Engineering, University of Texas, Austin, Texas, USA

Leon S. Lasdon

Department of Management Science and Information Systems, University of Texas, Austin, Texas, USA

Received 25 January 2001; revised 17 October 2001; accepted 17 October 2001; published 26 June 2002.

[1] Sustainable water management in irrigation-dominated river basins attempts to ensure a long-term, stable, and flexible water supply to meet crop water demands, as well as growing municipal and industrial water demands, while mitigating negative environmental consequences. To achieve this delicate balance, new models are needed which can use indicators of sustainability to guide the decision-making process. This paper presents a new long-term modeling framework which uses quantified sustainability criteria in a long-term optimization model of a basin, ensuring risk minimization in water supply, environmental conservation, equity in water allocation, and economic efficiency in water infrastructure development. “Current” and “future” water supply and demand are combined into a coherent system which takes account of the cumulative effects of short-term water use decisions and deals with the tradeoffs between the benefits of current and future generations. The modeling framework is demonstrated with an application to the Syr Darya River Basin of central Asia. Model results show the effectiveness of this tool for policy analysis in the context of the river basin. *INDEX TERMS:* 6344 Policy Sciences: System operation and management; 1842 Hydrology: Irrigation

1. Introduction

[2] The concept of sustainable development, popular in planning since the Brundtland Commission report [*World Commission on Environmental and Development*, 1987], is now recognized by water resources researchers and policy makers as an important research topic [Loucks, 2000]. Documents resulting from various national and international conferences, working groups, or committees, have identified some broad guidelines and principles [*U.N. Conference on Environment and Development*, 1992; *Organization for Economic Cooperation and Development*, 1998; *Loucks and Gladwell*, 1999]. These reflect some important concepts of sustainability in water resources planning, such as demand management, supply reliability and flexibility, negative impact control, technology adaptation, financial feasibility, and economic efficiency. While these broad guidelines provide assistance and guidance to planners and decision makers, they have not been translated into operational concepts that can be applied to the region-specific design, operation, and maintenance of water resources systems [Biswas, 1994]. Also, since most of the guidelines address qualitative aspects of the problem, they must be transformed into quantitative plans of action that provide precise guidance for making decisions. Hence an

analytical framework that incorporates quantifiable sustainability criteria into water resource systems models is needed.

[3] Modeling sustainability in water resources management requires specifying the relations between water uses and their long-term consequences, and combining “current” and “future” water availability and demand into a coherent system, which accounts for the tradeoffs in benefits received over many generations. To address these issues, a long-term modeling framework is needed. In this paper we present such a framework for modeling sustainability in irrigation-dominated river basins. The problem is of long-term, sustainable water resources management in river basins with (semi) arid climate, heavy dependence on irrigated agriculture, and the potential for severe environmental degradation in the form of water and soil salinity. In this context, sustainable water management can be defined as ensuring long-term, stable, and flexible water supply capacity to meet crop water demands, as well as growing municipal and industrial water demands, while simultaneously mitigating negative environmental consequences from irrigation.

[4] Section 2 presents an overview of the modeling framework, including quantified sustainability criteria. Section 3 discusses the solution approach using a hybrid genetic algorithm and linear programming (GA-LP) method, and in section 4 the new modeling framework is applied to a specific case study area, the Syr Darya River Basin in central Asia. Section 5 provides some conclusions.

2. Long-Term Water Resources Management Modeling Framework

[5] The core of the modeling framework presented here is an Interyear Control Program (IYCP) and a sequence of yearly models (YMs). The yearly model for year y , YM^y , is a short-term (annual) optimization model that maximizes total water use net benefit in a river basin for that year. The IYCP is a long-term model that uses sustainability criteria to control relations between short-term irrigation practices and their long-term socioeconomic and environmental consequences (see Figure 1). The thesis of this paper is that intrayear, short-term decisions should be controlled by long-term (multiyear) sustainability criteria in order to discover sustainable design and operation decisions.

2.1. Yearly Model

[6] The yearly model is an integrated hydrologic-agronomic-economic model, which reflects the interdisciplinary nature of sustainability analysis and includes both economic and environmental consequences of policy choices. This is a basin-scale model that includes physical processes at the farm and crop field levels. It is based on a node-link network, with source nodes such as rivers, reservoirs, and groundwater aquifers and demand site nodes such as agricultural, municipal, industrial (MI), and ecological demand sites and hydropower stations. Detailed agricultural water demand, in-stream water uses, including flow release for environmental and ecological use, and hydropower generation are modeled. A brief description of the yearly model formulation is provided in section 2.1.1. Details are given by Cai [1999]. In addition, McKinney *et al.* [1999] provide a comprehensive review of integrated hydrologic-agronomic-economic models at the basin scale, and Rosegrant *et al.* [2000] illustrate a specific application of such a model in Chile.

2.1.1. Yearly model objective function

[7] The objective of the yearly model (YM^y) is to maximize the total net benefit (TB^y) of water use in any year (y):

$$\text{Maximize } TB^y = \sum_d IB_d^y + HP^y + EB^y, \quad (1)$$

where HP^y is the hydropower profit, EB^y is the ecological net benefit, d is the index for agricultural demand sites, and IB_d^y is the irrigation profit, given by

$$IB_d^y = \sum_c PA_{d,c}^y (P_c^y YLD_{d,c}^y - C_c^y) - \sum_t PW_d^y (WD_d^{y,t}) - TAX_d^y (SALT_d^y), \quad (2)$$

where t is the within-year time period (month), c is a crop index, $PA_{d,c}^y$ is the planted crop area, P_c^y is the crop price, C_c^y is the cropping cost, $WD_d^{y,t}$ is the irrigation water withdrawal, PW_d^y is the irrigation water price, TAX_d^y is the salt discharge tax rate (effluent charge), $SALT_d^y$ is the salt discharged back to the river, and $YLD_{d,c}^y$ is the crop yield, a function of both soil moisture ($SW_{d,c}^{y,t}$) and soil salinity ($SS_{d,c}^y$):

$$YLD_{d,c}^y = f(SW_{d,c}^{y,t}, SS_{d,c}^y | YLD_{d,c}^{*y}), \quad (3)$$

where $YLD_{d,c}^{*y}$ a data item, is the potential crop yield based on other production inputs, assuming no water stress or

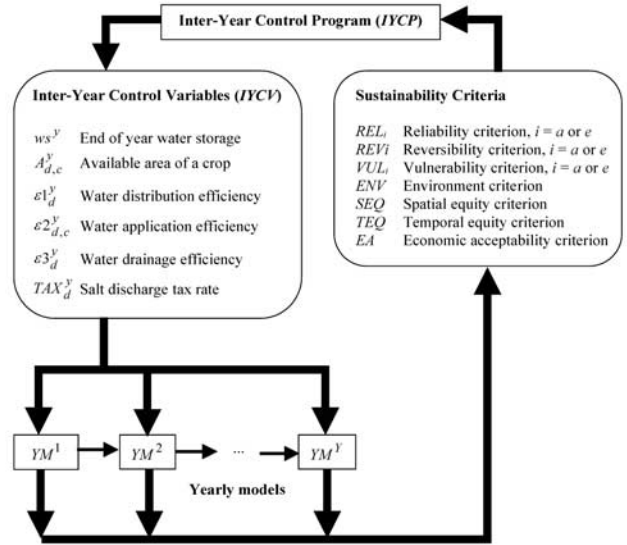

Figure 1. Overview of the structure of the long-term model.

salinity effect [U.N. Food and Agriculture Organization (UNFAO), 1979]. This nonlinear function is based on a combination of an empirical yield-water relationship [UNFAO, 1979] and an empirical yield-salinity relationship [Mass and Hoffman, 1977]. Full details of the yield function are given by Cai [1999]. The state variables $SW_{d,c}^{y,t}$ and $SS_{d,c}^y$ are calculated on the basis of the quantity and salinity of water inflows and outflows and infrastructure characteristics, including water distribution efficiency ($\epsilon 1_d^y$, the ratio of water arriving at a demand site to the total water diverted to that site), field application efficiency ($\epsilon 2_{d,c}^y$, the ratio of water available for use by crops to the total water applied to fields at a site), and drainage efficiency ($\epsilon 3_d^y$, the ratio of drained area to total irrigated area at a site), as well as initial soil moisture $SW_{d,c}^{y,t-1}$ and salinity $SS_{d,c}^{y-1}$:

$$SW_{d,c}^{y,t} = SW(\epsilon 1_d^y, \epsilon 2_{d,c}^y, \epsilon 3_d^y, WD_d^{y,t} | SW_{d,c}^{y,t-1}), \quad (4)$$

$$SS_{d,c}^y = SS(\epsilon 1_d^y, \epsilon 2_{d,c}^y, \epsilon 3_d^y, WD_d^{y,t}, SWD_d^y | SS_{d,c}^{y-1}), \quad (5)$$

in which SWD_d^y is the average salinity of water delivered to the demand site $WD_d^{y,t}$.

[8] The ecological water use benefit, EB^y , is calculated as

$$EB^y = BE^y (WECO^y), \quad (6)$$

where $WECO^y$ is the amount of water for ecological use, and BE^y is the socioeconomic net benefit per unit of ecological water use. Hydropower generation is approximately expressed as a linear relation with water release through the turbines, and the hydropower profit is

$$HP^y = \sum_t \sum_{st} (PPW_{st} - CPW_{st}) \left(\alpha_{1,st} Q_{(n^*,n2)}^t + \alpha_{2,st} \right), \quad (7)$$

where, PPW_{st} and CPW_{st} are the power selling price and generation cost for station st , respectively, n^* is a reservoir

with a hydropower station, and $\alpha_{1,st}$ and $\alpha_{2,st}$ are regression coefficients estimated from a series of hydropower and reservoir release values.

2.1.2. Major constraints

[9] Major constraints in the yearly model include the following:

1. Flow balances at nodes, n , representing river reaches, reservoirs, aquifers, and crop root zones

$$\sum_{n1 \in (n1,n)} Q_{(n1,n)}^t - \sum_{n2 \in (n,n2)} Q_{(n,n2)}^t - L_n^t = S_n^t - S_n^{t-1}, \forall n, \forall t, \quad (8)$$

where $Q_{(n1,n)}^t$ and $Q_{(n,n2)}^t$ are the inflows from node $n1$ (an upstream node, including sources) to node n and releases from node n to node $n2$ (a downstream node), respectively, during month t , and S_n^t is the storage at the end of month t , and L_n^t is loss associated with node n . For river reaches and other nonstorage nodes, we have $S_n^t - S_n^{t-1} = 0$.

2. Salinity balances of river reaches, reservoirs, aquifers, and crop root zones,

$$\sum_{n1 \in (n1,n)} Q_{(n1,n)}^t C_n^{y,t} - \left(\sum_{n2 \in (n,n2)} Q_{(n,n2)}^t + L_n^t \right) C_n^{y,t} = S_n^t C_n^{y,t} - S_n^{t-1} C_n^{y,t-1}, \forall n, \forall t, \quad (9)$$

where $C_n^{y,t}$ is the salt concentration of node n in month t of year y .

3. Policy constraint equations or variable bounds. These include, for example, maximum reservoir releases to control flooding, minimum flow for environmental control, etc. In particular, to avoid depleting reservoir storage due to high water use benefits in a single year, a constraint is added (for each major reservoir) which specifies the amount of water that must remain in storage at the end of a year (WS^y) for future use. This applies only to reservoirs with capacities large enough for multiyear flow regulation, and it is implemented as the constraint

$$\sum_{n \in n^*} S_n^T \geq WS^y, \quad (10)$$

where T is the last month of a year and n^* is the set of multiyear storage reservoirs.

[10] The major state variables of the yearly model (YM^y) include water storage (S_n^t), water salinity ($C_n^{y,t}$), soil moisture ($SW_{d,c}^{y,t}$), and soil salinity ($SS_{d,c}^{y,t}$). The major decision variables include reservoir and aquifer releases and pumping rates ($Q_{n,n2}^t$), water withdrawals to demand sites ($WD_{d,c}^t$), planted crop areas ($PA_{d,c}^y$), and water for ecological purposes ($RWECO^y$). The yearly models are solved sequentially over a long time horizon (say, 30 years). As described below, the over-year reservoir storage (WS^y) and soil variables ($SW_{d,c}^{y,t}$ and $SS_{d,c}^{y,t}$) are used to link the YM^y from year to year.

2.2. Solving the Yearly Model

[11] Since the yearly models (YM^y) have both flows and salt concentrations as state variables, they contain a large number of nonlinear constraints (e.g., (9)). These terms are bilinear and they increase model solution time substantially over that of a linear model. To increase solution speed, separate yearly flow (FM^y) and salt models (SM^y) are

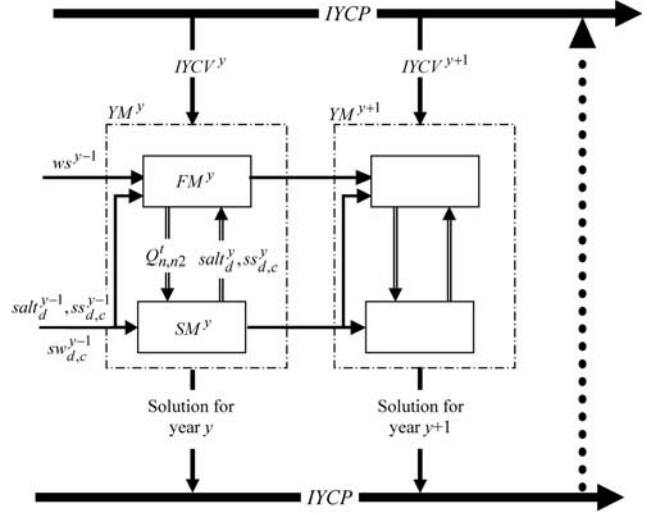

Figure 2. Structure of the long-term model.

formed by omitting constraints with concentration variables from the FM^y but leaving them in the SM^y . When modeling over the long term (e.g., 30 years), it is reasonable to compute only seasonal changes in soil and water salinity. Therefore the salt models (SM^y) are solved with a seasonal (i.e., quarterly) time step. Figure 2 illustrates the decomposition of the YM^y into FM^y and SM^y .

[12] First, the FM^y is solved using known soil salinity and salt discharge values from the previous year $y-1$ ($SS_{d,c}^{y-1}$ and $SALT_d^{y-1}$). The resulting monthly flows from FM^y are aggregated into seasonal flows for use in the SM^y . Given values for the seasonal flow, the SM^y is solved with the objective of minimizing root zone salt accumulation, subject to the salt balance equations, which are now linear since the flow variables are fixed. Solution of the SM^y provides values for the salinity variables ($SS_{d,c}^y$, $SALT_d^y$) which are used in the next iteration of the FM^y to update the crop production function and the salt discharge in the irrigation benefit equation. After this decomposition process the FM^y and SM^y are linear programs, which are much easier and faster to solve than the original, nonlinear YM^y . The iteration between the FM^y and SM^y stops when the change in the FM^y objective value is below a prescribed tolerance.

3. Interyear Control Program

3.1. Interyear Control Variables

[13] The function of the interyear control program (IYCP) is to control the long-term effects of the yearly models by specifying certain long-term decision variables, which are sent to each YM^y , $y = 1, \dots, Y$. These interyear control variables (IYCV) have long-term implications and control or constrain the short-term decisions in each YM^y . A set of IYCV includes end of year reservoir storage, WS^y ; the efficiencies, $\epsilon 1_{d,c}^y$, $\epsilon 2_{d,c}^y$, and $\epsilon 3_d^y$; available crop areas, $A_{d,c}^y$; salt discharge tax rates, and $TAX_{d,c}^y$ for each year in the modeled horizon, $y = 1, \dots, Y$. In the IYCP the IYCV are limited by bounds and constraints: WS^y must be less than the total available reservoir storage and greater than the dead storage; $\epsilon 1_{d,c}^y$, $\epsilon 2_{d,c}^y$, and $\epsilon 3_d^y$ must be nondecreasing and bounded above by 1.0; $TAX_{d,c}^y$ must lie in a certain range

and $\sum A_{d,c}^y \leq A_d^y$, where A_d^y is the total available area for site d in year y .

3.2. IYCP Objective Function

[14] In long-term water resources development and management, undesirable outcomes have both natural and anthropogenic causes, such as natural salinity levels, excessive water withdrawal or pollution discharges. The long-term cumulative effects of development and management actions may worsen the situation year by year, and finally lead to unavoidable disasters and irrecoverable negative effects.

[15] One approach to sustainability (actually, “strong sustainability”) requires that (1) the overall stock of capital assets of a system remain constant over time, (2) natural resource capital be preserved, and (3) system operation and management comply with an upper bound constraint on the assimilative capacity of the system and a lower bound on the level of natural resources necessary to support development [Turner, 1993]. Thus sustainability imposes restrictions on resource-using economic activities and requires resource stocks to be maintained within bounds consistent with ecosystem stability and resilience. A set of physical indicators is required in order to monitor compliance with these constraints and to measure economic performance and ecosystem stability and resilience. The analysis framework presented here is an attempt to implement this strong sustainability concept in a model.

[16] The interyear control variables (IYCV) are selected by the IYCP to maximize the long-term objective function, which is a linear combination of sustainability criteria. These criteria include risk (agricultural and ecological water supply), environmental integrity, equity (temporal and spatial), and economic acceptability. Each of these criteria is defined and discussed below. They have wide applicability but are of particular importance in irrigation-dominated regions where threatening water stress and environment problems exist. These criteria are used as long-term controls on short-term decisions in the yearly models (YM^y).

3.2.1. Risk criteria

[17] Risk in water resources management is often described by three characteristics [Hashimoto *et al.*, 1982; Kundzewicz and Kindler, 1995]: reliability (frequency of system failure), reversibility (time required for a system to return from failure), and vulnerability (severity of system failure). We propose quantitative measures for each of these risk characteristics and incorporate them into the IYCP. These risk criteria are expressed in terms of changes in irrigated area and water available for ecological use.

[18] The ratio of the total planted area in year y , determined in the yearly models (YM^y), to the total available area in year y , determined by the IYCP, is

$$RA^y = \frac{\sum_d \sum_c HA_{d,c}^y}{\sum_d A_d^y}. \quad (11)$$

[19] The ratio of water for ecological use (WECO^y), determined in the yearly models (YM^y), to the target use (TWECO^y) in year y is

$$RWECO^y = \frac{WECO^y}{TWECO^y}, \quad (12)$$

where TWECO^y are given data based on ecological requirements in the study area. The irrigated area and the ecological water use components of the risk criteria are defined for agricultural and ecological water uses:

[20] Reliability (REL) is defined as the weighted sum of the long-term averages of RA^y and RWECO^y:

$$REL = \beta(REL_a) + (1 - \beta)REL_e, \quad (13a)$$

where

$$REL_a = \frac{1}{Y} \sum_{y=1}^Y RA^y \quad (13b)$$

$$REL_e = \frac{1}{Y} \sum_{y=1}^Y RWECO^y, \quad (13c)$$

where the subscripts α and e denote agricultural and ecological components, respectively, and $0 \leq \beta \leq 1$ is a weight assigned to balance these two aspects.

[21] Reversibility (REV) is defined as the weighted sum of the relative time (to the total modeling years), in which RA^y or RWECO^y is continually below a specified threshold,

$$REV = \beta REV_a + (1 - \beta)REV_e, \quad (14a)$$

where

$$REV_a = \frac{YF_a}{Y} \quad (14b)$$

$$REV_e = \frac{YF_e}{Y}, \quad (14c)$$

where YF_α is the number of consecutive years that $RA^y < 1 - \alpha_\alpha$, and α_α is a safety threshold (in percent). For example, $\alpha_\alpha = 0.15$ means at most the irrigated area can be reduced by 15% before a failure is recorded, and if $RA^y < 1 - \alpha_\alpha = 0.85$, the system performance is a failure. Similar definitions apply for YF_e , which is the number of consecutive years in which $RWECO^y < 1 - \alpha_e$, where α_e is the threshold for ecological water use.

[22] Vulnerability (VUL) is defined as a weighted sum of the minimum values of RA^y and RWECO^y over the modeling horizon

$$VUL = \beta(VUL_a) + (1 - \beta)VUL_e, \quad (15a)$$

where

$$VUL_a = \min_y RA^y, \quad (15b)$$

$$VUL_e = \min_y RWECO^y. \quad (15c)$$

3.2.2. Environmental criteria

[23] Besides the risk criterion for ecological water use described above, we consider other environmental criteria, which reflect the effects of short- and long-term irrigation practices on environmental resources in the basin. One of the commonly accepted conditions of sustainability is a requirement of nonnegative changes in stocks of natural resources, such as soil and soil quality, ground and surface

water and their quality, and the waste-assimilative capacity of receiving environments [Dasgupta, 1995; Pearce and Turner, 1990]. Here we consider the control of surface and groundwater salinity and soil salinity through the definition of an environmental criterion (ENV)

$$\text{ENV} = \frac{1}{2} \left\{ \frac{\max_{y,t,n} (C_n^{y,t})}{C^0} + \frac{\max_{y,d,c} (SS_{d,c}^y)}{SS^0} \right\}, \quad (16)$$

where C^0 and SS^0 are maximum allowed water (surface and groundwater) and soil salinities, respectively, and the factor of 1/2 scales the criterion to the range (0,1). By minimizing ENV in the IYCP, the worst salinity conditions are mitigated to the extent possible and given all other factors in the model. This acts to preserve the environmental resources of the basin over the long run.

3.2.3. Equity criteria

[24] Sustainability is considered to be a matter of more than simple economic efficiency but, rather, a balancing of intragenerational and intergenerational equity [Turner, 1993]. Equity criteria are used in the model to (1) ensure that water use benefits are nondecreasing in all years (temporal equity) and (2) ensure that people at different locations in the river basin have equitable access to water supply for agricultural development (spatial equity). As described by Tsur and Dinar [1995], equity criteria can be descriptive (on the basis of the dispersion of the benefit profile) or normative (on the basis of an underlying social welfare function). In this study we use descriptive equity criteria. However, it should be noted that other measures are possible and may lead to different results. In addition, we note that collective, rather than individual actions, are usually required to affect the implied balances and tradeoffs of benefits between generations and spatial locations [Turner, 1993]. Here we are trying to illustrate the development and use of a tool which can aid in the process of decision making, but we are not trying to design the institutional framework to enact such policies.

[25] Temporal equity characterizes the distribution of water use benefits across generations. We express this in a descriptive fashion as the standard deviation of the annual rate of change of the total net benefit of water use (TB^y , see (1)). To calculate equity over time, we use the fractional change of TB^y , between years y and $y - 1$:

$$\Delta TB^y = \frac{TB^y - TB^{y-1}}{TB^y}, \quad y = 2, 3, \dots, Y. \quad (17)$$

The indicator of temporal equity (TEQ) is defined as the standard deviation of ΔTB^y :

$$\text{TEQ} = \sqrt{\frac{\sum_{y=2}^Y (\Delta TB^y - \Delta \bar{T}B)^2}{Y - 2}}, \quad (18)$$

where $\Delta \bar{T}B$ is the time average of ΔTB^y . A larger value of TEQ reflects a larger dispersion of the rate of change of water use benefits over the modeled horizon, implying a future in which benefits are uncertain and difficult to predict. The ideal value of TEQ is zero, corresponding to a constant, and more certain, growth rate of TB^y over time.

[26] Spatial equity characterizes the distribution of agricultural benefits across various demand sites in the basin. This is expressed as the standard deviation of the long-term average rate of change of irrigation profit (IB_d^y , see (2)) for all demand sites. For each demand site we calculate the average fractional change in IB_d^y over all years:

$$\Delta \bar{I}B_d = \frac{1}{Y - 1} \sum_{y=2}^Y \frac{IB_d^y - IB_d^{y-1}}{IB_d^y}. \quad (19)$$

The indicator of spatial equity (SEQ) is defined as the standard deviation of $\Delta \bar{I}B_d$ over all demand sites:

$$\text{SEQ} = \sqrt{\frac{\sum_{d=1}^D (\Delta \bar{I}B_d - \Delta \bar{\bar{I}}B)^2}{D - 1}}, \quad (20)$$

where $\Delta \bar{\bar{I}}B$ is the average of $\Delta \bar{I}B_d$ over all demand sites, and D is the number of demand sites. A larger SEQ implies a larger dispersion of irrigation benefit among the demand sites. The ideal value of SEQ is zero, when the time average growth rate of benefits is the same for all demand sites.

3.2.4. Economic acceptability criteria

[27] The IYCP selects various water infrastructure improvements, such as increases in distribution, irrigation, and drainage efficiencies. The investments necessary to implement these improvements are calculated as a function of the water saved through the incremental efficiency improvements. The investment in year y for site d is

$$\begin{aligned} \text{INV}_d^y &= \text{IDS}_d (\varepsilon 1_d^y - \varepsilon 1_d^{y-1}) \sum_t \text{WD}_d^{y,t} \\ &+ \text{IRR}_d \sum_c (\varepsilon 2_{d,c}^y - \varepsilon 2_{d,c}^{y-1}) \sum_t \text{WD}_d^{y,t} (1 - \varepsilon 1_d^y) \\ &+ \text{IDN}_d (\varepsilon 3_d^y - \varepsilon 3_d^{y-1}) \sum_c \text{HA}_{d,c}^y, \end{aligned} \quad (21)$$

where IDS_d and IRR_d are the required investment per unit of water savings from distribution and irrigation systems improvements, respectively, and IDN_d is the required investment per hectare of new drained area.

[28] When the marginal costs of additional water infrastructure improvements are higher than the additional marginal benefits, these investments lose their economic acceptability. We define economic acceptability criterion (EA) as

$$\text{EA} = \frac{\text{TB} - \text{TB}_0}{\text{INV} - \text{INV}_0}, \quad (22)$$

where

$$\text{TB} = \sum_{y=1}^Y \text{TB}^y / (1 + \gamma)^{(y-1)} \quad (23)$$

$$\text{INV} = \sum_{y=1}^Y \sum_{d=1}^D \text{INV}_d^y / (1 + \gamma)^{(y-1)}, \quad (24)$$

where TB_0 and INV_0 are the total water use benefit and investment resulting from an alternative scenario, and γ is

the discount rate. With this criterion, it is necessary that $EA \geq 1$ for an investment to be attractive.

[29] Selecting a discount rate is troublesome. As γ increases, future effects become less important. High discount rates tend to discourage investment in long-term conservation of natural resources. Low discount rates, however, may favor investment in projects that are less likely to be justified economically. Therefore an ambiguous relationship exists between discount rates and sustainable management. *Kopp and Portney* [1997] argued that the selection of discount rates in the application of benefit-cost analysis was difficult and even problematic because people must trade off their own well-being in the current period for that of generations yet unborn. Several authors argue for a zero discount rate when considering sustainability, especially where long-term environmental impacts are likely to occur [Turner, 1993]. Selection and verification of an appropriate discount rate for sustainable development in a specific area need further research, which should be wider and more detailed in dealing with tradeoffs between current and future generations. In this study we have put more emphasis on preserving certain resources (water quantity and quality, land, SEQ, TEQ, etc.) for future generations rather than trying to determine the tradeoffs embodied in selecting a discount rate.

[30] According to these sustainability criteria, no strong linear relationships exist between them; that is, the change of one criterion is not proportional to the change of any other criterion, and these criteria are more or less competitive in the long-term objective. Strong tradeoffs exist between these criteria, especially between water supply reliability and environmental integrity, and between equity and economic efficiency [Cai, 1999].

[31] It should be noted that the definitions of the sustainability criteria presented above are not unique and may not be appropriate for every application. However, we think our choices are reasonable for the specific study of this paper, that is, water management in irrigation-dominated river basins with an arid or semi-arid climate where salinity is a major problem.

3.2.5. IYCP objective function

[32] Incorporating the sustainability criteria presented above into the IYCP objective function results in a multiple-criteria optimization problem. Except for REL and EA, which are maximized, all other criteria are minimized, so REL and EA are incorporated with minus signs. The long-term objective function is a weighted sum of these indices:

$$\min F = -\omega_1 \text{REL} + \omega_2 \text{REV} + \omega_3 \text{VUL} + \omega_4 \text{ENV} + \omega_5 \text{TEQ} \\ + \omega_6 \text{SEQ} - \omega_7 \text{EA} \quad (25)$$

where, $\omega_i = 1, \dots, 7$ are weights (summing to 1.0) reflecting a decision maker's preference to each criterion. This has been widely discussed in literature of multiple-objective decision making [e.g., Chankong and Haimes, 1983].

[33] The results of the sequence of yearly models (YM^y), over a long time horizon ($y = 1, \dots, Y$), under a particular selection of the interyear control variables (IYCV) are used to calculate the sustainability criteria, which are then used to calculate the IYCP objective function value. The components of the IYCP objective function depend on the optimal

solutions of the yearly models (YM^y), and these are non-smooth and/or nonconvex functions of the IYCV, the decision variables of the IYCP. A combined genetic algorithm and linear programming (GA-LP) approach was designed by the authors to find an acceptable approximation to a global solution for this problem. This new GA-LP method is described briefly in section 3.3. Full details are given by *Cai* [1999] and [Cai et al., 2001].

3.3. Solving the IYCP

[34] Genetic algorithms (GA) belong to a family of optimization techniques in which the solution space is searched by generating candidate solutions with the help of a random number generator. These algorithms rely on collective learning processes within a "generation" of solutions. For each generation, the "fitness" of each individual solution is calculated for each individual in the population of solutions. The fitness of an individual solution is used to propagate good solutions to the next generation, thereby producing improved solutions [Goldberg, 1989]. Higher probabilities of participating in the next generation are assigned to individual solutions with better fitness values. In short, the solution procedure for the IYCP is the following:

1. Create a generation, g , consisting of I sets of interyear control variables ($IYCV_{g,i}$, $i = 1, \dots, I$), where I is the number of individuals in the population of solutions and g is the generation number ($g = 0$ for the initial generation). Various constraints and bounds on the interyear control variables are applied in the generation procedure. Each individual i , $i = 1, \dots, I$ in this population of alternative solutions is a set of values of the interyear control variables:

$$IYCV_{g,i} = \left\{ IYCV_{g,i}^1, \dots, IYCV_{g,i}^Y \right\} \\ = \left\{ \left(WS^1, \epsilon 1_d^1, \epsilon 2_{d,c}^1, \epsilon 3_d^1, A_{d,c}^1, TAX_d^1 \right)_{g,i} \right. \\ \left. , \dots, \left(WS^Y, \epsilon 1_d^Y, \epsilon 2_{d,c}^Y, \epsilon 3_d^Y, A_{d,c}^Y, TAX_d^Y \right)_{g,i} \right\}; \quad (26)$$

2. Using linear programming, solve the yearly models (YM^y) sequentially for $y = 1, \dots, Y$ using each individual from the population $IYCV_{g,i}$, $i = 1, \dots, I$ in turn, i.e., $YM_{g,i}^y = YM^y(IYCV_{g,i})$.

3. On the basis of the results from the $YM_{g,i}^y$, $y = 1, \dots, Y$ in step 2, calculate the IYCP objective function value $F_{g,i} = F(YM_{g,i}^y)$ for each member i of generation g , and hence the fitness of each individual in the population ($I = 1, \dots, I$).

4. The fitness values for generation g are then used in the GA process to generate an improved population of interyear control variables for the next generation $IYCV_{g+1,i}$ ($i = 1, \dots, I$). The solution strategy is to test the population of interyear control variables ($IYCV_{g+1,i}$, $i = 1, \dots, I$) in each generation and to search for the best among the population on the basis of a process of evolutionary selection and improvement. The search criterion is the IYCP objective function. A combined genetic algorithm and linear programming (GA-LP) approach is used to implement this strategy. Figure 3 shows a diagram of the approach. This search process continues for a number of generations, gradually finding an improved IYCP objective and,

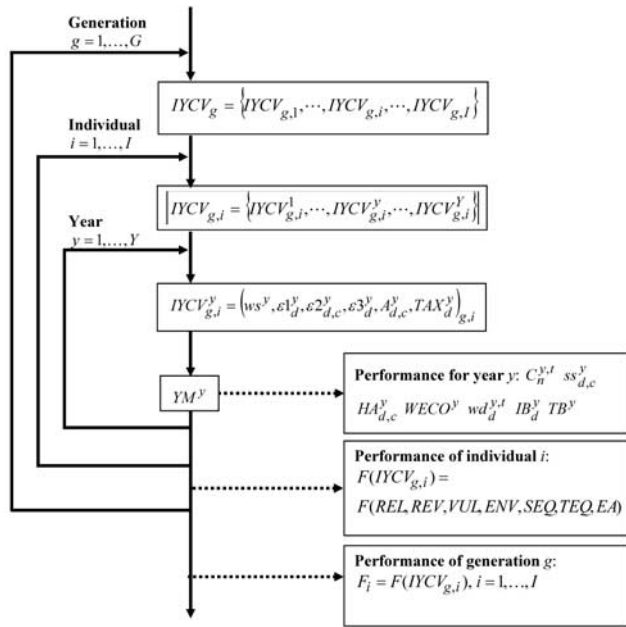

Figure 3. Diagram of the genetic algorithm and linear programming approach.

ultimately, an approximation to the global solution of the IYCP.

4. Application of the Modeling Framework

4.1. Case Study Area: The Syr Darya River Basin

[35] The Syr Darya River Basin is one of the two major rivers feeding the Aral Sea (see Figure 4). It begins at the Pamir and Tien Shan plateaus, crosses the territories of four central Asian republics, Kyrgyzstan, Tajikistan, Uzbekistan, and Kazakhstan, before terminating in the northern Aral Sea. The basin’s water supply system comprises 9 major tributaries, 11 reservoirs, and numerous irrigation distribution systems and canals. Irrigation is important to the economic development of the area because a large portion of the national economies (40–50% of gross domestic product) is derived from irrigated agriculture [World Bank, 1996]. However, intensive withdrawal of water for irrigation has led to decreased inflow to the Aral Sea, increased salt and other pollutant discharge to the river system, soil waterlogging, and salinization [Glantz, 1999; McKinney and Kenshimov, 2000]. Facing these environmental impacts, one can question whether such a high level of irrigated agriculture can be sustained while reversing or minimizing the adverse environmental impacts.

[36] The Syr Darya River Basin is a vital resource for the republics it flows through. Because of the transboundary flow of water within the region, water management is a very complicated issue and has a high potential for creating conflicts among the republics. An inequitable allocation of water could significantly disadvantage the economic position of one or more of the republics. Typical upstream-downstream water conflicts exist in the basin, including water depletion, timing problems created by water storage for hydropower production, and water quality deterioration in the lower reaches of the river [McKinney and Kenshimov, 2000].

[37] These issues are at the heart of sustainable water resources management for the basin. The environmental problems in the basin and in the whole Aral Sea region present a very serious lesson in unsustainable water resources development. This is directly related to intensive irrigation expansion, widespread introduction of high-water-demanding monocrops (e.g., cotton and rice), poor water distribution and conveyance systems and low-efficiency irrigation techniques, and large-scale non-dose-related uses of fertilizers and pesticides. In this paper we apply the modeling framework described above to analyze some of these issues. This case study was undertaken to demonstrate the application of the modeling framework, its possibilities and its limitations.

4.2. Assumptions

[38] Raskin et al. [1992] identified the six irrigation demand sites along the Syr Darya shown in Figure 4. These were the primary agricultural areas developed under the Soviet Union. These six demand sites are used in the model. The five major crops considered are cotton, wheat, forage, maize, and alfalfa; all others are grouped into a single crop. The planning horizon modeled is 30 years, and the data for the base year are derived from information about the basin in the early 1990s. Details are provided by Cai [1999].

[39] For modeling purposes a scenario of inflow to the basin over the next 30 years was generated following a projection made by Raskin et al. [1992]. Five categories of years are used to represent hydrologic patterns, with probabilities of occurrence of 3.3% (very wet = 1.27 × normal), 16.7% (wet = 1.12 × normal), 52.0% (normal), 21.3% (dry = 0.76 × normal) and 6.7% (very dry = 0.59 × normal), respectively. We assume that no new reservoir capacity is

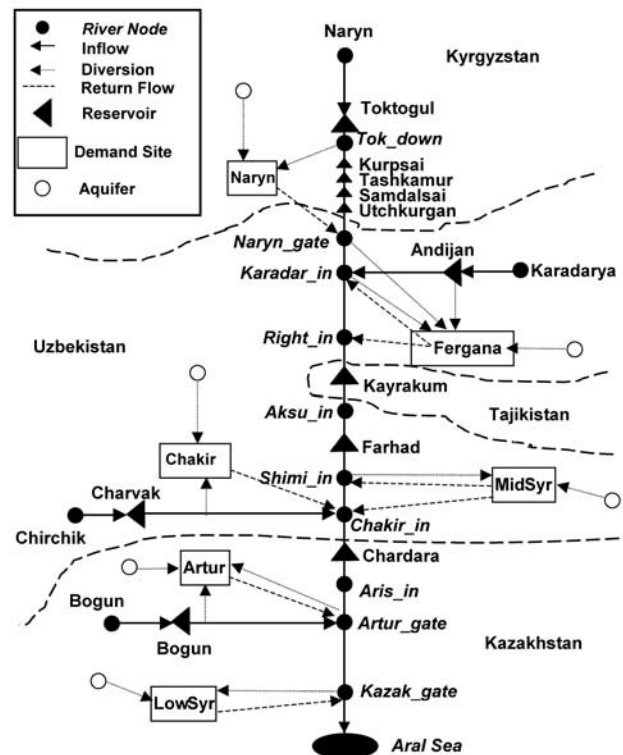

Figure 4. The Syr Darya River Basin network.

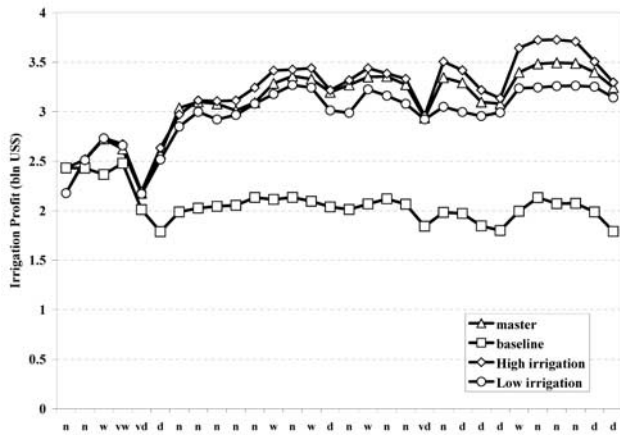

Figure 5. Irrigation profit under the various scenarios. The x axis represents the hydrologic year series with the following representations: n, normal; w, wet; vw, very wet; d, dry; vd, very dry.

added over the 30-year modeling horizon and that the existing reservoirs maintain their current active storage capacity.

[40] Projected crop areas are given in the description of the scenarios that follow. The target for ecological flow (TWECO³) is assumed to be the average flow to the northern Aral Sea from the river during 1965–1975. This flow satisfies the inflow requirement to the Aral Sea from the Syr Darya River on the basis of the five-country agreement on flow to the Aral Sea [McKinney and Kenshimov, 2000]. Net benefit per unit of ecological water use (BE) is estimated on the basis of that given by Anderson [1997]. Salinity tax rate is assumed to be in a range of 0–200 US\$/ton.

[41] The discount rate is set to zero for the analysis of the Syr Darya River Basin. This is based on the serious threats to future water uses posed by past and current water resources usage and the existing environmental problems. This zero discount rate puts priority on long-term water management practices and protection of environmental assets. However, the verification of the discount rate for the study area needs further research.

[42] Weights for sustainability criteria in the IYCP objective function represent important decision tools. To demonstrate the application of the modeling framework to the case study area, equal weights are applied to all criteria, and the sum of these weights is equal to 1.0. Obviously, these weights do not represent final decision-maker preferences, but they serve to demonstrate the modeling approach in a realistic setting.

[43] Regarding water management institutions, in the Syr Darya Basin, the riparian countries have agreed to an allocation of water use rights between the countries and an Interstate Coordinating Water Commission has been established to approve annual allotments according to these shares and the predicted runoff in any given year. This body could use results from the YM³ and the IYCP to develop plans of water storage and release for reservoir operation under various hydrologic conditions, tax rates for salinity control, and water allocations in accordance with water rights. Other items such as infrastructure parameters (efficiencies) and crop areas can be used to guide national

government or farmer infrastructure development and crop pattern change.

4.3. Model Scenarios and Results

[44] To explore the effects of changes in water uses, several scenarios have been defined. In each case a 30-year modeling horizon is used with varying hydrologic conditions over the horizon. The scenarios include the following:

1. The baseline scenario has no change in current water use status. This scenario assumes that the current crop pattern, irrigated area, and infrastructure are maintained over the 30-year modeling horizon.

2. The master scenario assumes a 5% increase in the irrigated area and a 25% increase of municipal and industrial (MI) water demand over the modeling horizon with equal yearly changes. In this scenario the irrigated area, and distribution, irrigation, and drainage efficiencies are determined by the model.

3. The low-irrigation scenario assumes a 5% increase in the irrigated area and a 25% increase of municipal and industrial (MI) water demand over the modeling horizon with equal yearly changes. In this scenario the irrigated area and distribution, irrigation, and drainage efficiencies are determined by the model.

4. The high-irrigation scenario is the master scenario with irrigated area increasing 10% from the baseline scenario in the next 30 years, with equal yearly changes.

4.3.1. Master scenario versus baseline scenario

[45] There are marked differences between the master and baseline scenarios, as well as economic and environmental outcomes. The irrigation profit and flow release to the Aral Sea under the two scenarios are plotted in Figures 5 and 6, respectively. Under the baseline scenario, irrigation profit decreases sharply after the first drought period and never recovers because of increasing water demands without simultaneous infrastructure improvement in later years. After the first drought period, the irrigation profit of the baseline scenario is almost half that of the other scenarios. This is mainly due to (1) large reduction in cotton area of the baseline scenario without any crop pattern change, while the master scenario switches significant area from cotton to less-water-intensive wheat (see Figure 7); and (2) increased

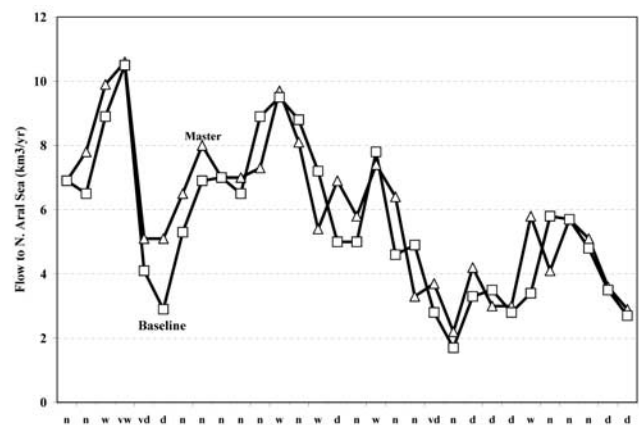

Figure 6. Flow to the northern Aral Sea under the baseline and the master scenarios.

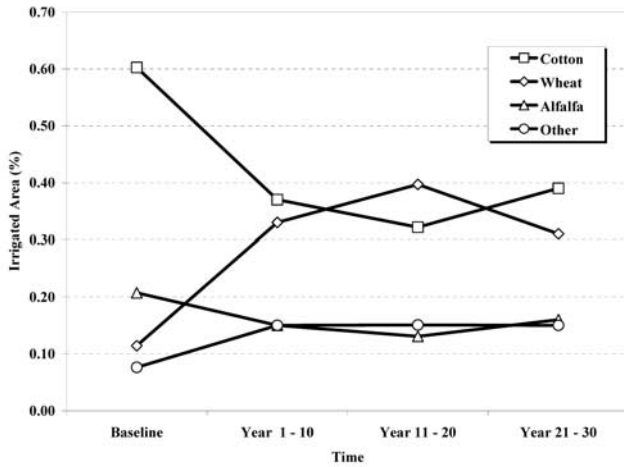

Figure 7. Comparison of crop areas over three decades for the master scenario.

efficiencies, especially application efficiency $\epsilon_{2d,c}^y$ in the master scenario (Figure 8).

[46] Under the baseline scenario, the 30-year average flow reaching the Aral Sea is 5.6 km^3 , while it is 6.0 km^3 under the master scenario. Thus water withdrawal under the baseline scenario is larger than that under the master scenario because of the current crop pattern and low distribution efficiency, as discussed below.

[47] To achieve the gains of the master scenario, irrigated area for crops and water supply and use infrastructure must be determined endogenously by the model. Figure 7 shows the change in irrigated area by crop over the three-decade modeling period. Compared with the baseline scenario, by the end of the modeling period, irrigated area for wheat has increased to about 30% of total area, and cotton has decreased from 60% to about 40%. This shows that, according to the model and assumptions used here, the cotton-dominated crop pattern may not be sustainable in this region, because of high-water consumption and soil salinity accumulation from irrigating this relatively salt-tolerant crop. It is important to point out that the final crop acreage and pattern are determined on the basis of a global search over 30 years. Therefore the cotton area does not shift back immediately in the time following the first drought period. However, as can be seen in Figure 7, in later years, after irrigation and drainage efficiencies have increased, the area of cotton, which is normally a high-valued crop, increases. Therefore the model implies a crop rotation in the basin’s long-term irrigation planning.

[48] Model results from the master scenario provide useful guidance for infrastructure improvements. Figure 8 shows the distribution (ϵ_{1d}^y), application (ϵ_{2d}^y , averaged over all crop fields), and drainage (ϵ_{3d}^y) efficiencies at major demand sites from upstream to downstream (Fergana, mid Syr, and low Syr) throughout the modeled period. All the efficiencies show significant increases. Increases in efficiency are postponed at the upstream sites in favor of downstream improvements. Distribution efficiency at the upstream sites (Fergana and mid Syr) increases dramatically only after year 15. The reasons for this may include the following: (1) The return flow from the upstream distribution losses can be reused by downstream sites; and (2) water

availability is more limited downstream, which makes higher distribution efficiency more valuable there.

[49] Application efficiency increases moderately in the first 5 years upstream (Fergana) but remains constant after that. At midstream (mid Syr), a dramatic increase in efficiency (from 55–77%) is seen over the modeled period, which has a very large impact on salinity downstream. The midstream application efficiency increase results in the increased irrigation profit from higher yields resulting from lower soil salinity and less waterlogging; it is also beneficial to downstream because of the reduction of return flow which helps to reduce downstream salinities.

[50] For drainage efficiency, a large increase (from 53% to 80%) occurs for the mid-Syr site. Data from the mid-1990s show that the midstream area of the basin has a large risk of waterlogging [European Commission, 1995]. The model result is consistent with this observation, and it shows that midstream improvement of the drainage system is important.

[51] Salt discharge tax rates depend on many factors, including hydrologic level, water withdrawal for irrigation, and drainage status. Tax rates (TAX_d^y) are higher for the

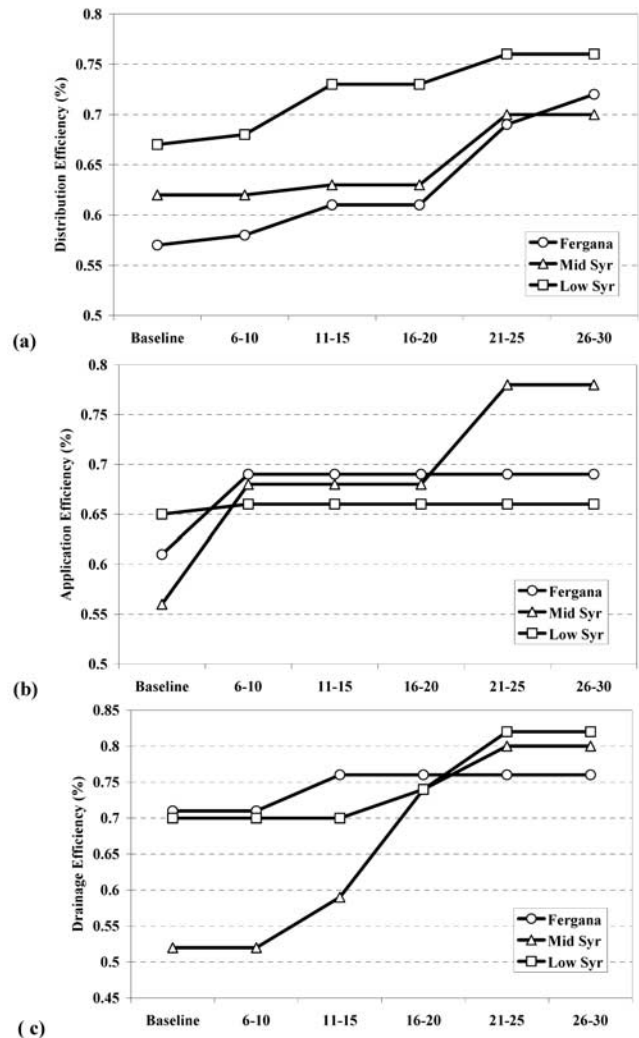

Figure 8. (a) Distribution, (b) application, and (c) drainage efficiencies for the master scenario.



Figure 9. Salt discharge under the high- and low-irrigation scenarios.

upstream demand sites and higher in later years when salt discharge increases relative to the current level (see Figure 9). Moreover, the high-irrigation scenario results in higher tax rates for all demand sites, especially in later years.

4.3.2. High- and low-irrigation scenarios

[52] The results show that the high-irrigation scenario has higher irrigation profit than the low-irrigation scenario in almost every year (see Figure 5). However, in drought periods, the differences are small, since irrigated area must be reduced because of water deficits in those years. The average annual releases to the Aral Sea under the low- and high-irrigation scenarios are 6.6 km³/yr and 5.4 km³/yr, respectively; 22% higher for the low-irrigation scenario, but the former has 6.5% less irrigation profit. In the long-term a strong tradeoff exists between irrigation and environmental water uses.

[53] Larger irrigated areas cause higher annual salt discharge (up to 200%) and higher soil salinity (up to 150%) in future years, as shown in Figures 9 and 10. The results show that, even in the low-irrigation scenario, increasing salt discharge will occur, especially from the middle and downstream demand sites; however, soil salinity remains constant. This is an indication that current conditions are not

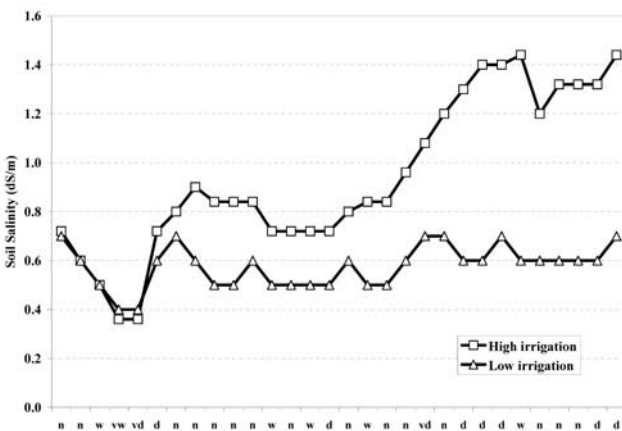

Figure 10. Soil salinity (low-Syr site, cotton crop) under the irrigation scenarios.

sustainable. To alleviate this problem, further reductions in irrigated area beyond 10% may be needed, as well as enhanced drainage disposal measures such as evaporation ponds. Note that the master scenario falls between the results of the high- and low-irrigation scenarios.

4.3.3. Risk criteria

[54] Table 1 presents values for the risk criteria (reliability, reversibility, and vulnerability) under the various scenarios modeled:

1. Regarding agricultural reliability (REL_a), under the assumption that crop yield should not be lower than half of its maximum value, the current irrigated area (baseline scenario) may be sustained under various water supply conditions, even though crop yields decline dramatically in dry years. For the baseline scenario, on average, 97% of the available area is utilized in irrigated agriculture. The master and low-irrigation scenarios achieve 100% utilization, while the high-irrigation scenario results in 96% utilization, similar to the baseline. For agricultural reversibility (REV_a) a failure year with regard to irrigated area is defined as a year where the ratio RA^y of planted to available area is less than $\alpha_a = 0.85$ (a 15% risk threshold). Under all scenarios, there are no years in which a cutback in planted area of more than 15% is required. For agricultural vulnerability the results show that all the scenarios experience cutbacks in planted area ranging from 1% ($VUL_a = 0.99$) in the low-irrigation scenario to 11% in the baseline scenario.

2. For environmental risk criteria, ecological water use is measured as the flow into the northern Aral Sea from the Syr Darya River, which is quite sensitive to infrastructure conditions. Regarding environmental reliability (REL_e), we have assumed that flow to the northern Aral Sea from the Syr Darya River should not be less than that agreed by the riparian basin nations. For the baseline scenario, on average, 44% of the required flow is released to the Sea. The master and low-irrigation scenarios achieve 82–85% release, while the high-irrigation scenario results in 59% release, similar to the baseline. Thus in the case of the master scenario, we see that the reliability of flow to the sea is almost doubled compared with the baseline conditions. For environmental reversibility, a failure year is defined as a year where the ratio $RWECO^y$ of water released to the sea is less than $\alpha_e = 0.85$ (a 15% risk threshold). Under all scenarios, there are failures, ranging from 6.7% of the 30 years (2 consecutive years in which $RWECO^y$ is less than 85%) in the low-irrigation scenario to 56.7% of the 30 years in the baseline scenario (17 consecutive years in which $RWECO^y$ is less than 85%). The master scenario is 200% more successful in providing the flow than the baseline. For environmental vulnerability all the scenarios experience deficits in release to the sea, ranging from 99% under the baseline scenario (minimum $RWECO^y$ is only 1%) to 50% under the low-

Table 1. Risk Criteria Under Various Scenarios^a

Scenario	Reliability		Reversibility		Vulnerability	
	REL_a	REL_e	REV_a	REV_e	VUL_a	VUL_e
Baseline	0.97	0.44	0	0.567	0.89	0.01
Master	1.00	0.82	0	0.100	0.98	0.44
Low irrigation	1.00	0.85	0	0.067	0.99	0.50
High irrigation	0.96	0.59	0	0.267	0.91	0.10

^a Variables are defined in notation section.

Table 2. Environmental Criterion Under Various Scenarios^a

Scenario	Maximum Groundwater Salinity $\max(C_n^{y,t})_{y,t,n}$			Maximum Surface Water Salinity $\max(C_n^{y,t})_{y,t,n}$		Maximum Soil Salinity $\max(SS_n^{y,t})_{y,t,n}$			ENV
	Upstream ^b	Midstream ^c	Downstream ^d	Midstream ^e	Downstream ^f	Upstream ^b	Midstream ^c	Downstream ^d	
Baseline	1.85	2.52	2.14	1.66	1.17	0.45	0.56	0.80	0.50
Master	1.59	1.72	2.08	1.47	1.06	0.63	0.65	0.85	0.44
Low irrigation	1.42	1.67	1.95	1.50	1.00	0.40	0.60	0.78	0.42
High irrigation	1.88	2.30	2.69	1.83	1.15	1.22	1.36	1.89	0.64

^a Variables are defined in notation section.

^b Location is Fergana.

^c Location is mid-Syr.

^d Location is low-Syr.

^e Location is Kayrakum.

^f Location is Chardara.

irrigation scenario. Again, the master scenario is at least 200% more effective than the baseline. Under the baseline scenario, without infrastructure improvements, the environmental risk is clearly very high. Similar conditions occur under the high-irrigation scenario, although reliability and reversibility are somewhat improved since infrastructure improvement is provided. The low-irrigation scenario has less environmental risk than all other scenarios.

4.3.4. Environmental criteria

[55] The environmental criteria try to maintain the environmental resources of the basin, which are represented by the water and soil salinities in the basin. The baseline scenario results (Table 2) in the smallest soil salinity but the highest groundwater salinity at midstream (mid-Syr). This is because low application efficiency allows more salt to be leached from the crop root zone, while low drainage efficiency allows drainage with high salinity to enter groundwater. The high-irrigation scenario leads to higher groundwater and surface water salinities and the largest soil salinity. The low-irrigation scenario results in a better salinity status, especially for soil salinity. The value of the environment criterion (ENV) for each scenario shows that the high-irrigation scenario has the highest criterion value, representing the worst environmental condition, the baseline has the second highest, and lower and close values are found for the master and low-irrigation scenarios, with low irrigation having the best value.

4.3.5. Equity criteria

[56] The values of the equity criteria, temporal equity (TEQ) and spatial equity (SEQ), are shown in Table 3 for the various scenarios. Temporal equity (TEQ) is affected by changes in water demand, as well as hydrologic fluctuations over the years. Variations in temporal equity are more significant than those in spatial equity, for the high-irrigation scenario, which has the highest value. The low-irrigation scenario has the lowest value, indicating the high stress put on the agricultural production system in the high-irrigation scenario (200% increase over the master sce-

nario). Spatial equity (SEQ) is very low for all scenarios, indicating that the variation of water use benefit among demand sites is small. SEQ is worse in the high-irrigation scenario and best in the master scenario.

4.3.6. Economic acceptability criterion

[57] The economic acceptability criterion, EA, compares investments for infrastructure improvements and their corresponding benefits (see Table 4). Under the baseline scenario no investment takes place, but there is a sizable decline in profit compared with other scenarios, indicating that infrastructure improvements will be necessary to sustain an irrigated agriculture dominated economy in this basin.

[58] A standard benefit-cost analysis process was used to compare the modeled scenarios. Since all alternatives have a benefit (B) to cost (C) ratio $B/C > 1$, they are ranked in terms of investment cost and a contender is compared against the current best alternative. If $\partial B/\partial C > 1$ for that pair, then the contender becomes the best alternative. This process is repeated for all alternatives, and the results are shown in Table 4. The results imply that a large (10%) increase in irrigated area is not a good idea. If the cost of developing the new lands was included, the result would be even worse. From these results the low-irrigation scenario is not preferred to the master scenario. Recall that the master scenario has a 5% increase in irrigated area over the modeled period; the low- and high-irrigation scenarios each have 10% decrease and increase, respectively. The average irrigated areas in the last 5-year period for the three scenarios are the following: master, 3419 thousand hectares; low irrigation, 2998 thousand hectares; and high irrigation, 3556 thousand hectares. The master scenario has more irrigated land than the low-irrigation scenario, which implies that taking too much land out of production is not a good idea, either.

[59] The EA indicator does not capture the full array of sustainability indicators. Table 5 summarizes the rankings of each scenario in terms of the sustainability criteria. The IYCP uses the aggregated objective function to search for a solution for a single modeled scenario. However, one cannot really compare this aggregate objective value between scenarios, and all that can be done is to present the array of sustainability criteria from the scenarios and discuss what they mean. From these results we see that the low-irrigation and master scenarios seem to have many positive attributes compared with the other scenarios.

5. Conclusions

[60] A modeling framework has been developed in which intrayear (short-term) decisions are combined with

Table 3. Equity Criteria Under Various Scenarios^a

Scenario	TEQ	SEQ
Baseline	0.182	0.009
Master	0.109	0.005
Low irrigation	0.096	0.007
High irrigation	0.236	0.016

^a Variables are defined in notation section.

Table 4. Economic Acceptability Under Various Scenarios^a

Scenario	TB	INV	ΔTB	ΔINV	$\frac{\Delta TB}{\Delta INV}$
Baseline	91.1	0.00
Low irrigation	92.4	8.7	$(92.4 - 91.1) = 1.3$	8.7	$1.3/8.7 = 0.15$
Master	104.6	9.6	$(104.6 - 91.1) = 13.5$	9.6	$13.5/9.6 = 1.4$
High irrigation	97.5	10.8	$(97.5 - 104.6) = -7.1$	$10.8 - 9.6 = 1.2$	$-7.1/1.2 = -5.9$

^aAll values are in billions of U.S. dollars.

interyear (long-term) decisions to help find sustainable development patterns in irrigation-dominated river basins. Moreover, specific sustainability criteria are proposed and incorporated into a long-term optimization model of a river basin, taking into account risk minimization in water supply, environmental integrity, spatial and temporal equity in water allocation, and economic efficiency in infrastructure development. Long-term decisions, based on sustainability criteria, are used to guide the short-term decisions in an attempt to achieve sustainability in water management.

[61] For demonstration purposes the new model has been applied to the Syr Darya River Basin in central Asia. Model outputs include proposals for long-term reservoir operations, water supply, facility improvements, irrigation development, and crop pattern changes. Results show that both long-term soil and water salinity are very sensitive to changes in irrigated area, and even small increases in irrigated area without accompanying investments in infrastructure improvements places the environment at risk, especially in downstream demand sites. Restoring future flows to the northern Aral Sea (the mouth of the Syr Darya River) to the 1965–1975 level will have a significant impact on agricultural production in the basin unless infrastructure improvements are made in a careful manner. Improvements in the current infrastructure and changes in current crop patterns are necessary to sustain agricultural production and the environment in the basin.

[62] We believe that these results are realistic and demonstrate that this new modeling framework is an effective tool for river basin sustainability analysis. However, the results herein should not be taken as a final analysis of water problems in the basin. They must be extended and verified by further work. To bring this tool from research to practice, additional work will include verifying some important parameters for sustainability analysis, such as the discount rates, screening alternative weights for competitive sustainability criteria, testing other forms of sustainability measure-

ment, and developing an innovative methodology to incorporate uncertainty analysis, especially regarding the stochastic hydrologic patterns, into the modeling framework. With all these being well supported, the modeling framework proposed can promote understanding of sustainable policies in the basin context.

Notation

Indices and Sets

- c crop.
- d agricultural demand site.
- g generation number.
- i individual in the population of solutions.
- n node (rivers reaches, reservoirs, aquifers, and crop root zones).
- t month.
- y year.

State variables of yearly model

- $C_n^{y,t}$ ground or surface water salinity (g/L).
- S_n^t water storage (km^3).
- $SW_{d,c}^{y,t}$ soil moisture (km^3).
- $SS_{d,c}^y$ soil salinity (dS/m).
- $SWD_{d,c}^{y,t}$ salinity with irrigation water (g/L).

Decision variables of yearly model

- $HA_{d,c}^y$ planted area of a crop (ha).
- $Q_{(n,n2)}^t$ flow from node n to node $n2$ (km^3).
- $WD_d^{y,t}$ irrigation water withdrawal (km^3).
- $WECO^y$ water for ecological use (km^3).

Other variables of yearly model

- EB^y ecological net benefit (\$).
- HA_d^y total planted crop area (ha).
- HP^y hydropower profit (\$).
- IB_d^y irrigation profit (\$).
- L_n^t water losses (km^3).

Table 5. Ranking of Scenarios by Various Sustainability Criteria^{a,b}

Scenario	Risk			Environment ENV	Equity		Economic Acceptability EA
	REL	REV	VUL		TEQ	SEQ	
Baseline	4	4	4	3	3	3	NA
Master	2	2	1	2	2	1	1
Low irrigation	1	1	2	1	1	2	2
High irrigation	3	3	3	4	4	4	3

^aVariables are defined in notation section.

^bRanking values are as follows: 1, best; 4, worst.

$Q_{(n1,n)}^t$	flow from node $n1$ to node n during time period t .	IRR_d	investment per unit of water savings from irrigation systems ($\$/m^3$).
RA^y	ratio of planted to available area (dimensionless).	IDN_d	investment per hectare of new drained area ($\$/ha$).
RWECO ^y	ratio of actual to target of water for ecological use.	P_c^y	crop price ($\$/ton$).
SALT _d ^y	salt discharged back to the river.	PPW_{st}	power selling price for station st ($\$/KWH$).
TB ^y	total net benefit of water use ($\$$).	PW_d^y	irrigation water price ($\$/km^3$).
YLD _{d,c} ^y	crop yield (ton/ha).	$Q_{(n1,n)}^t$	source flow from node $n1$ to node n .
		SS^0	maximum allowable soil salinity (dS/m).
Decision variables of IYCP		TWECO	ecological water use target (km^3/yr).
$A_{d,c}^y$	available area of a crop.	Y	Total number of years.
$\varepsilon 1_d^y$	distribution efficiency (dimensionless).	YLD*	Potential crop yield (ton/ha).
$\varepsilon 2_{d,c}^y$	application efficiency (dimensionless).		
$\varepsilon 3_d^y$	water drainage efficiency (dimensionless).		
IYCV _{g,i}	individual in the population of interyearcontrol variables.		
TAX _d ^y	salt discharge tax rate ($\$/thousand tons$).		
WS ^y	end of year water storage (km^3).		
Other variables of IYCP			
A_d^y	total available area (ha).		
EA	economic acceptability criterion.		
ENV	environment criterion (dimensionless).		
F	long-term objective function value.		
$\frac{\Delta \overline{IB}_d}{\overline{IB}}$	average of the fractional change of IB_d^y .		
$\overline{\Delta \overline{IB}}$	average of $\Delta \overline{IB}_d$ over all demand sites.		
INV	present value of INV_d^y over all years.		
INV_d^y	investment in improved irrigation and drainage technologies.		
REL _k	reliability criterion, k being a (agricultural) or e (environmental).		
REV _k	reversibility criterion, k being a (agricultural) or e (environmental) (dimensionless).		
SEQ	spatial equity criterion, the standard deviation of $\Delta \overline{IB}_d$.		
TB	present value of TB^y .		
ΔTB^y	fractional change of TB^y , between years y and $y - 1$.		
TEQ	temporal equity criterion, the standard deviation of ΔTB^y .		
VUL _k	vulnerability index, k being a (agricultural) or e (environmental) (dimensionless).		
YF _k	number of consecutive years of failure, k equal to a (agricultural) or e (environmental).		
Data			
α_k	threshold for failure, k being a (agricultural) or e (environmental) (dimensionless).		
$\alpha_{1,st}, \alpha_{2,st}$	regression coefficients for linear hydropower relation.		
BE	net benefit per unit of ecological water use.		
β	risk criteria weight (dimensionless).		
C^0	maximum allowable water salinity (thousand tons per km^3).		
C_c^y	cropping cost ($\$/ha$).		
CPW _{st}	power generation cost for station st .		
D	total number of demand sites.		
I	number of individuals in the population of solutions.		
IDS_d	investment per unit of water savings from distribution systems ($\$/m^3$).		

[63] **Acknowledgments.** The authors are grateful to Paul Jakus, John Keith, and another anonymous reviewer for their very detailed and helpful comments and suggestions, which have led to considerable improvement to the early manuscript of this paper.

References

- Anderson, R. C., Environmental damage assessment of the Aral Sea disaster, *Iss. Pap. 1*, Environ. Policies and Technol. Proj., U.S. Agency for Int. Dev., Almaty, Kazakhstan, 1997.
- Biswas, A. K., Sustainable water resources development: Some personal thoughts, *Int. J. Water Resour. Dev.*, 10(2), 109–116, 1994.
- Cai, X., Modeling Framework for sustainable water resources management, Ph.D. dissertation, Univ. of Tex., Austin, 1999.
- Cai, X., D. C. McKinney, and L. Lasdon, Solving nonlinear water management models using a combined genetic algorithm and linear programming approach, *Adv. Water Resour.*, 24(6), 667–676, 2001.
- Chankong, V., and Y. Y. Haimes, *Multiobjective Decision Making: Theory and Methodology*, North-Holland, New York, 1983.
- Dasgupta, P., Optimal Development and the Idea of Net National Product, in *The Economics of Sustainable Development*, chap. 5, edited by I. Goldin and L. A. Winters, Cambridge Univ. Press, New York, 1995.
- European Commission, *Water Resources Management and Agricultural Production in the Central Asian Republics*, *Water Resour. Manage. and Agric. Prod. Proj. Rep.*, vols. 1–6, Brussels, 1995.
- Glantz, M. H., (Ed.), *Creeping Environmental Problems and Sustainable Development in the Aral Sea Basin*, Cambridge Univ. Press, New York, 1999.
- Goldberg, D. E., *Genetic Algorithms in Search, Optimization, and Machine Learning*, Addison-Wesley-Longman, Reading, Mass., 1989.
- Hashimoto, T., J. R. Stedinger, and D. P. Loucks, Reliability, resiliency, and vulnerability criteria for water resource system performance evaluation, *Water Resour. Res.*, 18(1), 14–20, 1982.
- Kopp, R. J., and P. R. Portney, Mock referenda for intergenerational decision making, *Discuss. Pap. 97–48*, Resour. for Future, Washington, D. C., August 1997.
- Kundzewicz, Z. W., and J. Kindler, Multiple criteria for evaluation of reliability aspects of water resource systems, in *Modeling and Management of Sustainable Basin-Scale Water Resource Systems*, Publ. 231, edited by S. P. Simonovic et al., Int. Assoc. of Hydrol. Sci., Wallingford, United Kingdom, 1995.
- Loucks, D. P., Sustainable water resources management, *Water Int.*, 25(1), 3–11, 2000.
- Loucks, D. P., and J. S. Gladwell (Eds.), *Sustainability Criteria for Water Resource Systems*, *Int. Hydrol. Ser.*, Cambridge Univ. Press, New York, 1999.
- Mass, E. V., and G. J. Hoffman, Crop salt tolerance-current assessment, *J. Irrig. Drain. Div. Am. Soc. Civ. Eng.*, 103(9), 115–134, 1977.
- McKinney, D.C., and A. K. Kenshimov (Eds.), *Optimization of the Use of Water and Energy Resources in the Syrdarya Basin Under Current Conditions*, *Tech. Rep. 00-06-W*, Environ. Policies and Inst. for Cent. Asia Program, U.S. Agency for Int. Dev., Almaty, Kazakhstan, 2000. (available at <http://www.ce.utexas.edu/prof/mckinney/papers/aral/00-06-W/EPIC-00-06-W.htm>)
- McKinney, D. C., X. Cai, M. Rosegrant, C. Ringler, and C. Scott, Integrated basin-scale water resources management modeling, working paper, Int. Inst. for Water Manage., Sri Lanka, January 1999.
- Organization for Economic Cooperation and Development, The Athens workshop: Sustainable management of water in agriculture: Issues and policies, *Rep. 511998081E1*, Paris, 1998.

- Pearce, D. W., and R. K. Turner, *Economics of Natural Resources and the Environment*, Johns Hopkins Univ. Press, Baltimore, Md., 1990.
- Raskin, P., E. Hansen, Z. Zhu, and D. Stavisky, Simulation of water supply and demand in the Aral Sea Region, *Water Int.*, 17(1), 55–67, 1992.
- Rosegrant, M. W., C. Ringler, D. C. McKinney, X. Cai, A. Keller, and G. Donoso, Integrated economic-hydrologic water modeling at the basin scale: The Maipo river basin, *Agric. Econ.*, 24(1), 33–46, 2000.
- Tsur, Y., and A. Dinar, Efficiency and equity considerations in pricing and allocating irrigation water, *Policy Res. Working Pap. 1460*, World Bank, Washington, D. C., 1995.
- Turner, R. K., Sustainability: Principles and Practices, in *Sustainable Environmental Economics and Management*, edited by R. K. Turner, Belhaven, London, 1993.
- U.N. Conference on Environment and Development, *Report of the United Nations Conference on Environment and Development (UNCED)*, chaps. 5 and 18, Rio de Janeiro, Brazil, 1992.
- U.N. Food and Agriculture Organization (UNFAO), Yield response to water, *Irrig. and Drainage Pap. 33*, Rome, 1979.
- World Bank, *Developing a Regional Water Management Strategy: Issues and Work Plan*, Aral Sea Basin Program Tech. Pap. Ser., Washington, D. C., 1996.
- World Commission on Environmental and Development, *Our Common Future, (The Brundtland Report)*, 338 pp., Oxford Univ. Press, New York, 1987.
-
- X. Cai, International Food Policy Research Institute, Washington, DC 20006, USA. (x.cai@cgiar.org)
- L. S. Lasdon, Department of Management Science and Information Systems, University of Texas, Austin, TX 78712, USA. (lasdon@mail.utexas.edu)
- D. C. McKinney, Department of Civil Engineering, University of Texas, Austin, TX 78712, USA. (daene@aol.com)